



# SCHOOL CATALOG



## Hear from a Pro

Time, Efficiency, Reliability

“After 20 years in the kiln repair business, I can say that L&L kilns last longer than other brands, and the cost of ownership is much lower. General maintenance like replacing elements can be done in half the time of most other brands, and they typically need fewer repairs because they are so durable. That can add up to a savings of several hundred dollars per kiln per year.”

-Neil Estrick -  
20+ years of kiln repair

### Ceramic Element Holders



Protect Your Brick



# Why Teach Ceramics?

## Impacts on Student Learning

Improve	May Reduce	Encourage	
<ul style="list-style-type: none"> <li>● Problem-Solving Skills</li> <li>● Hand-Eye Coordination</li> <li>● Fine Motor Skills</li> <li>● Focus</li> </ul>	<ul style="list-style-type: none"> <li>● Anxiety</li> <li>● Depression</li> <li>● PTSD</li> <li>● Anger</li> </ul>	<ul style="list-style-type: none"> <li>● Self Expression</li> <li>● Curiosity</li> <li>● Self-Discipline</li> </ul>	<ul style="list-style-type: none"> <li>● Story-Telling</li> <li>● Communication</li> <li>● Social Skills</li> </ul>

# Accessible For All

## Inclusive Education

**Sensory Stimulation:** Working with clay and ceramics involves tactile experiences, which can provide sensory stimulation. For individuals with learning disabilities, this hands-on activity may help in managing hyperactivity and improving focus.



Wedging To Remove Air



Wheel Throwing



Trimming & Defining Forms



Hand-building



Painting & Glazing Forms

# Core Skills Impact

## Beyond Fine Motor Skills

STEM Skills	Language Skills	Cross-Curriculum
<ul style="list-style-type: none"> <li>● Geometry</li> <li>● Measurements</li> <li>● Fractions</li> <li>● Patterns &amp; Symmetry</li> <li>● Chemistry</li> </ul>	<ul style="list-style-type: none"> <li>● Storytelling &amp; Writing</li> <li>● Vocabulary Development</li> <li>● Presentation Skills</li> <li>● Symbolism &amp; Metaphor</li> </ul>	<ul style="list-style-type: none"> <li>● Spark Student Engagement</li> <li>● Diverse Learning Styles</li> </ul>

# Easy for Teachers

Be a Pro

## Touch-Screen Control

- Simple, Intuitive Interface
- Phone App To Monitor
- Pre-Programmed Firings
- Customizable Options



### Genesis Touchscreen Video Guides

[hotkilns.com/support/videos](http://hotkilns.com/support/videos)

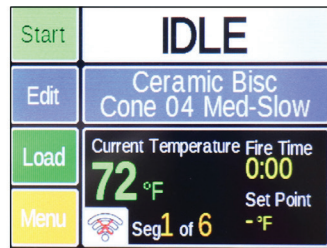

Genesis 2.0 with KilnAid app

Manufactured by Bartlett Instruments for L&L Kiln Mfg., Inc.



"Zone control allows me to keep loss to a bare minimum, as my bisque and glaze firings each need to reach their precise temperatures throughout the entire kiln to work well. Not only that, but I am able to control the cooling to achieve the glittery aventurine crystalline growth I love in my amber glazes. LOVE the firing accuracy top to bottom that make my clay and glaze combination a success in L&L kilns!"

- Lisa Orr - [lisaorr.com](http://lisaorr.com)



## Easy to Load

Features for Durability

- Spring Assist Lid
- Strong Kiln Furniture
- Protected Thermocouples
- Protected Brick



# Easy to Troubleshoot

Time = Money, Save Both

## Easy Maintenance

- Easy Element Changes
- Clean, Trouble-Free Interior
- Easy Trouble-Shooting
- Automatic Firing Logs

## L&L Solutions

- Hard Element Holders
- Self-Supporting Panels
- Ceramic Terminals
- Insulated Controls
- Quick-Ship Parts
- Online Parts Database
- Quick, Expert Service
- Instructional Videos



## No Expertise Needed

In-House Maintenance

**No other kiln manufacturer places so much emphasis on easy and safe maintenance.** This can be crucial not just for artists but for schools and institutions - because you will save time and money and keep your program running smoothly. L&L has unique features, like self-supporting, hands-free control panels, labeled wiring, ceramic element holders, and no-crimp element connections to make it easy and possible for in-house maintenance personnel, without kiln expertise, to maintain your kilns.

# Easy to Fix

Time = Money, Save Both

- 1 Hard Ceramic Element Holders
- 2 Straight-View Peephole Plugs
- 3 Protected Thermocouples
- 4 "No Crimp" Element Connections
- 5 Full-Support Stand
- 6 Genesis Touch Screen Control
- 7 Automatic Zone Control (on most models)
- 8 Easy-Open Spring Hinge
- 9 Easy Service Control Panel

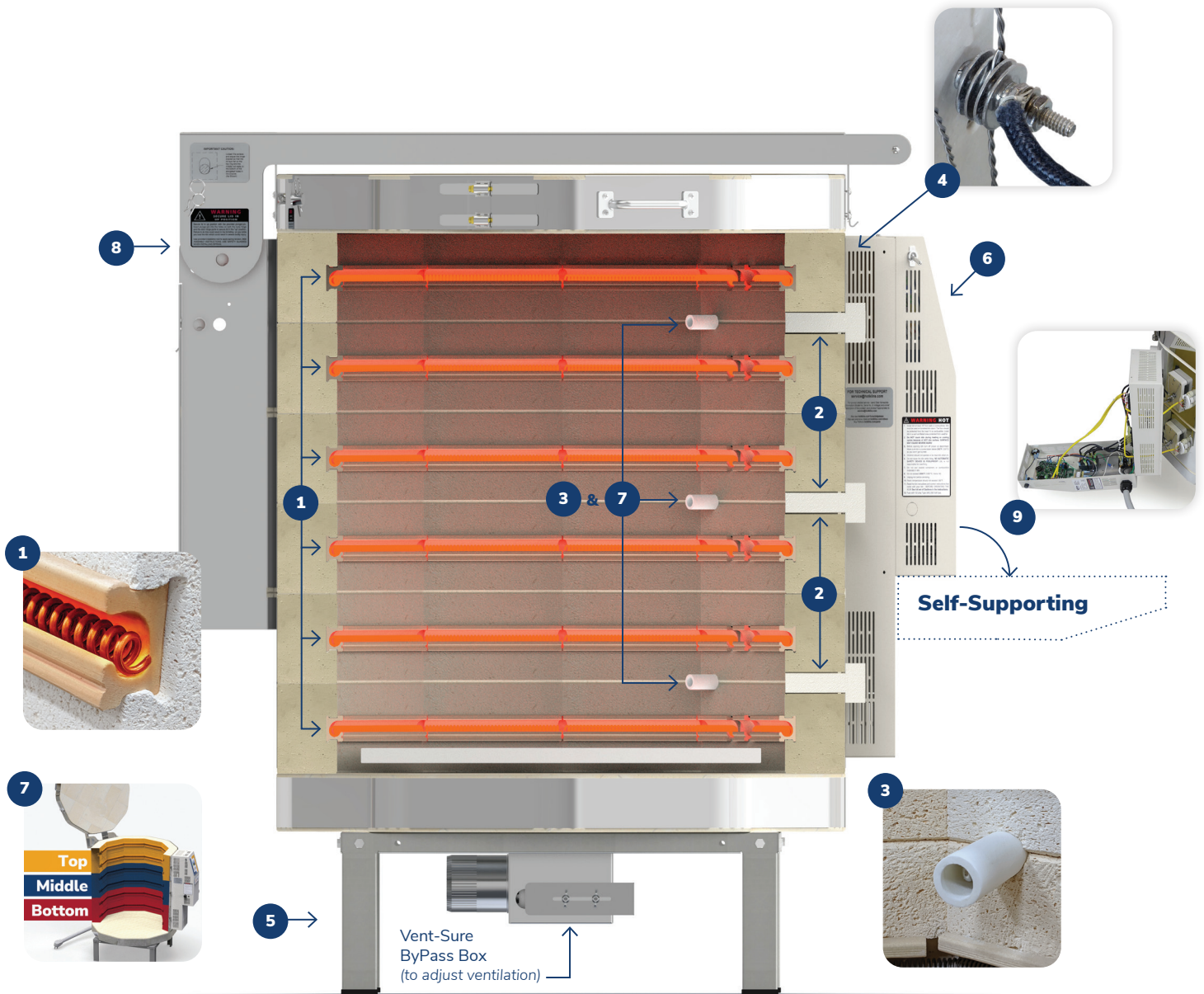

# Elementary & Middle For Low-Fire Programs

See [hotkilns.com/SM23T-3](http://hotkilns.com/SM23T-3) for all features and options

## School-Master SM23T-3

### Standard L&L Features

- Genesis Mini Touch Screen Control • with Kiln Aid app
- Hard Ceramic Element Holders • protect your elements and kiln
- Type K Thermocouple (1) • with protection tube
- 3" • K23 Brick
- Top Loading • Spring assisted lid
- Solid, Straight-View Peephole Plugs
- Full-Support Stand • rolling option available
- Easy-Access Control Panel • with Easy-View tilted display
- c-ETL-us listed to UL499 Standards

### Unique to School-Master

- Designed for Low Fire (Cone 1) • Max Cone 6 (2232°F)
- Multi-Voltage • (208v - 240v)
- Five-Year Limited Warranty
- Single Zone • graded elements for uniformity



### School-Master Package

- 1 - School-Master Kiln
- 1 -Vent-Sure Downdraft Vent System
- 1 - Furniture Kit
- 1 - Vent Controller



**SM23T-3  
Package**

School-Master Package  
[hotkilns.com/SM23T-3-Package](http://hotkilns.com/SM23T-3-Package)

# L&L Model Comparisons

## School-Master vs e23T-3 vs e28S-3

Model No.	No. Shelves F=full, H=half	Inside Diam	Inside Height	Cubic Feet	Exterior Dim (in)	240/1 KW~Amp~Fuse	240/3 KW~Amp~Fuse	208/1 KW~Amp~Fuse	208/3 KW~Amp~Fuse	Lbs Kiln	Lbs w/Kit
SM23T-3-A	20" (8H)	22.3"	27"	6.7	30W x 68H x 40D	11.5~48.0~60	11.5~27.8~40	9.0~43.2~60	9.0~27.9~40	380	470
e23T-3	20" (8H)	22.3"	27"	6.7	30W x 68H x 40D	11.5~48.0~60	11.5~27.7~40	10.0~48.0~60	11.0~30.5~40	380	470
e28S-3	25-1/2" (6H)	28"	18"	6.8	35W x 65H x 46D	11.5~47.9~60	11.5~41.5~60	10.0~48.0~60	10.0~41.6~60	410	520

See the kiln pages for other voltages

### SM23T-3 & e23T-3 Kiln Capacity

Example: 6" Diam x 3" Height Bowl  
Approximately 38 Bowls

#### SM23T-3

- **Temp Rating: Cone 1 (6 Max)**
- **Volume: 6.7 Cubic Feet**
- **Brick Thickness: 3" Brick**
- **Inside: 22.3" Diam x 27" H**

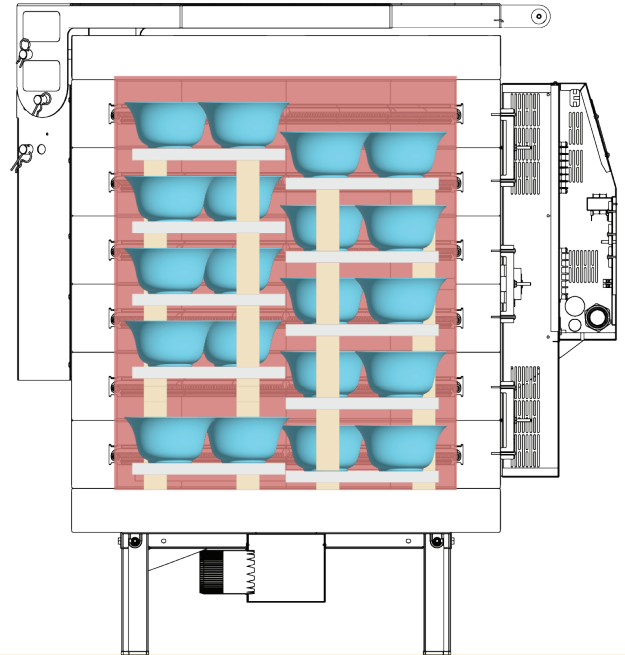
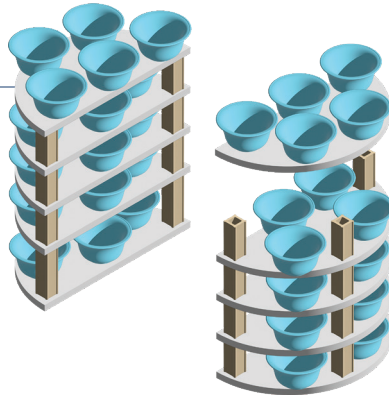

## Alternatives to School-Master For More Advanced Programs

**Easy-Fire e23T-3** [hotkilns.com/e23T-3-Package](http://hotkilns.com/e23T-3-Package)

**Easy-Fire e28S-3** [hotkilns.com/e28S-3-Package](http://hotkilns.com/e28S-3-Package)



**e23T-3  
Package**



- **Temp Rating: Cone 10**
- **Volume: 6.7 Cubic Feet**
- **Brick Thickness: 3" Brick**
- **Inside: 22.3" Diam x 27" H**
- **Capacity: Approx 38 Bowls (6" Diam x 3" H)**

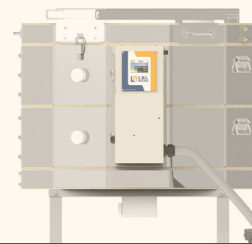

**e28S-3  
Package**



- **Temp Rating: Cone 10**
- **Volume: 6.8 Cubic Feet**
- **Brick Thickness: 3" Brick**
- **Inside: 28" Diam x 18" High**
- **Capacity: Approx 50 Bowls (6" Diam x 3" H)**

# Advanced Middle School and High School

See [hotkilns.com/eQ2827-3](http://hotkilns.com/eQ2827-3) for all features and options

## eQuad Pro Kilns (3 Sizes Available)

### Model Shown: eQ2827-3

- Genesis Touch Screen Control • with Kiln Aid app
- Dynamic Zone Control • for even firing
- Hard Ceramic Element Holders • protect your elements and kiln
- Type K Thermocouples (3) • with protection tubes
- 3" • K23 Brick
- Top Loading • spring assisted lid
- Solid, Straight View Peephole Plugs
- Full-Support Stand • rolling option available
- Easy-Access Control Panel • branch fusing included
- Three-Year Limited Warranty
- c-ETL-us listed to UL499 Standards

### Unique to eQuad-Pro

- Quad Element System Comes Standard
  - for extra long element life
- Cone 10 (2350°F) • with extra power



## eQ2827-3 Package

- 1 - eQ2827-3
- 1 - Vent-Sure Downdraft Vent System
- 1 - Furniture Kit
- 1 - Vent Controller



**eQ2827-3  
Package**

eQ2827 Package  
[hotkilns.com/eQ2827-3-Package](http://hotkilns.com/eQ2827-3-Package)

# L&L Model Comparisons

## e28M-3 vs e28T-3 vs eQ2827-3

Model No.	No. of Shelves All Half Shelves	Inside Diam	Inside Height	Cubic Feet	Exterior Dimensions	240/1 KW~Amp~Fuse	240/3 KW~Amp~Fuse	208/1 KW~Amp~Fuse	208/3 KW~Amp~Fuse	Lbs Kiln	Lbs w/Kit
e28M-3	25-1/2" (6H)	28"	22.5"	8.5	35W x 69H x 46D	11.5~48.0~60	16.6~40.0~50	10.0~48.0~60	14.3~39.8~50	445	555
e28T-3	25.5" (8H)	28"	27"	10.2	35W x 74H x 46D	11.5~48.0~60	16.6~40.0~50	10.0~48.0~60	14.3~39.8~50	475	610
eQ2827-3	25.5" (8H)	28"	27"	10.2	35W x 74H x 49D	15.0~62.3~80	15.0~36.0~50	15.0~71.9~90	15.0~41.5~60	515	650

See the kiln pages for other voltages

### e28T-3 & eQ2827-3 Kiln Capacity

Example: 6" Diam x 3" Height Bowl  
Approximately 74 Bowls

#### eQ2827-3

- **Temp Rating: Cone 10**
- **Volume: 10.2 Cubic Feet**
- **Brick Thickness: 3" Brick**
- **Inside: 28" Diam x 27" H**

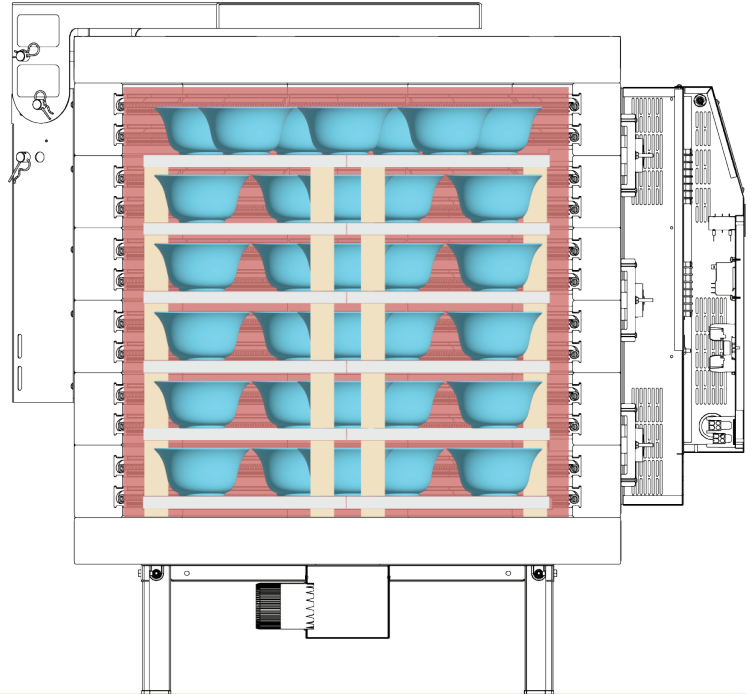
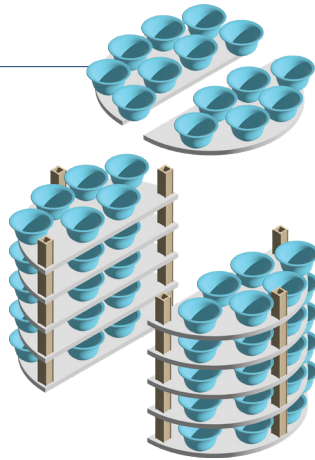

## Alternatives to eQ2827-3

### Cost, Size, & Power Alternatives

#### Easy-Fire e28M-3 [hotkilns.com/e28M-3-Package](http://hotkilns.com/e28M-3-Package)

#### Easy-Fire e28T-3 [hotkilns.com/e28T-3-Package](http://hotkilns.com/e28T-3-Package)

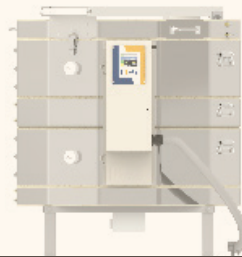

#### e28M-3 Package

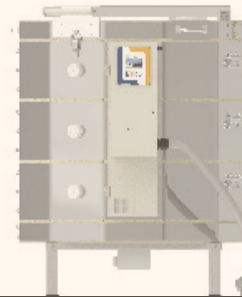

#### e28T-3 Package



- **Temp Rating:** Cone 10 (Cone 8 on 208V/1Ph)
- **Volume:** 8.5 Cubic Feet
- **Brick Thickness:** 3" Brick
- **Inside:** 28" Diam x 22.5" H
- **Capacity:** Approx 62 Bowls (6" Diam x 3" H)

- **Temp Rating:** Cone 10 on 3-phase models  
Cone 8 on 240V/1Ph  
Cone 5 on 208V/1Ph
- **Volume:** 10.2 Cubic Feet
- **Brick Thickness:** 3" Brick
- **Inside:** 28" Diam x 27" H
- **Capacity:** Approx 74 Bowls

## eFL Front-loading Kilns (3 Sizes Available)

### Model Shown: eFL2635

- **Genesis Touch Screen Control** • with Kiln Aid app
- **Dynamic Zone Control** • for even firing
- **Hard Ceramic Element Holders**
  - protect your elements and kiln
- **Cone 10 (2350°F)**
- **Type K Thermocouples (3)**
  - with protection tubes
- **Solid, Straight-View Peephole Plug**
- **Easy-Access Control Panel**
- **Three-Year Limited Warranty**
- **c-ETL-us listed to UL499 Standards**

### Unique to eFL Series

- **3" • K23 Brick** • balanced front to back with micro-porous backup insulation in door and K25 brick in the back • eliminates the need for door elements
- **Front-Loading**
- **Door Switch** • for safety

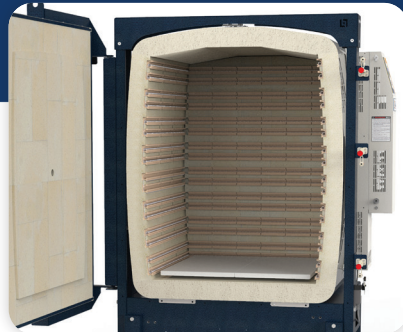

## eFL2635 Package

- 1 - eFL2635
- 1 -Vent-Sure Downdraft Vent System
- 1 - Furniture Kit
- 1 - Vent Controller



**eFL2635  
Package**

eFL2635 Package  
[hotkilns.com/eFL2635-Package](http://hotkilns.com/eFL2635-Package)

# L&L Model Comparisons

## eFL2635 vs Davinci X3227

Model Number	Kiln Shelves	Cubic Feet	Inside Height	Inside Dimensions	Exterior Dimensions	240/1 KW~Amp~Fuse	240/3 KW~Amp~Fuse	208/1 KW~Amp~Fuse	208/3 KW~Amp~Fuse	Lbs Kiln	Lbs w/Kit
eFL2635	(8) 12"x 24"	13.7	35"	26W x 35H x 26D	45W x 72H x 39D	19.2-80.0-100	19.2-52.9-70	19.2-92.3-125	19.2-61.1-80	895	900
X3227	(6) 14"x 28"	14.5	27"	30.5W x 27H x 30.5D	63W x 81H x 58.2D	18.04-75.2-100	18.04-43.4-60	18.04-86.7-110	18.04-50.1-70	1035	1170

See the kiln pages for other voltages

### eFL2635 Kiln Capacity

Example: 6" Diam x 3"Height Bowl  
Approximately 128 Bowls

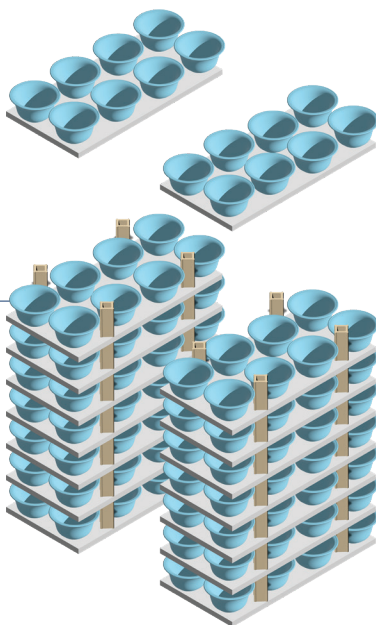

### eFL2635

- **Temp Rating: Cone 10**
- **Volume: 13.7 Cubic Feet**
- **Inside Dimensions:  
26" W x 35" H x 26" D**

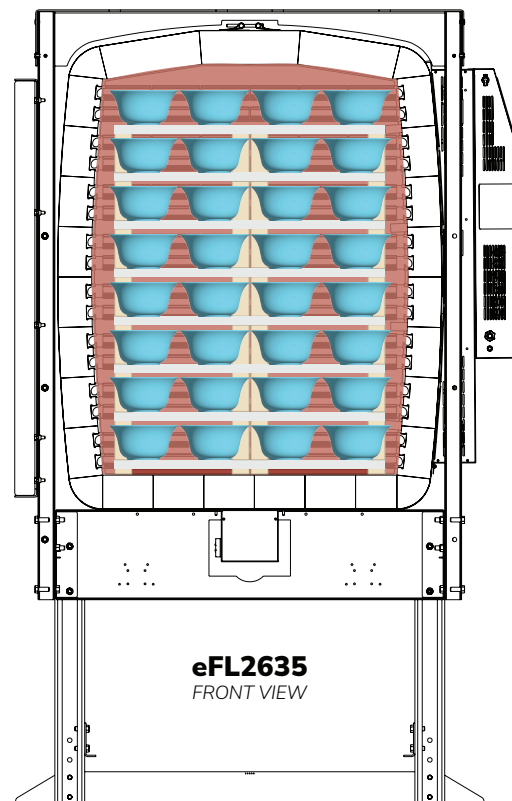

## Alternative to eFL Series

Cost, Size, & Power Alternative

**Davinci X3227** [hotkilns.com/kilns/x3227-electric-kiln](http://hotkilns.com/kilns/x3227-electric-kiln)



**Davinci  
X3227**

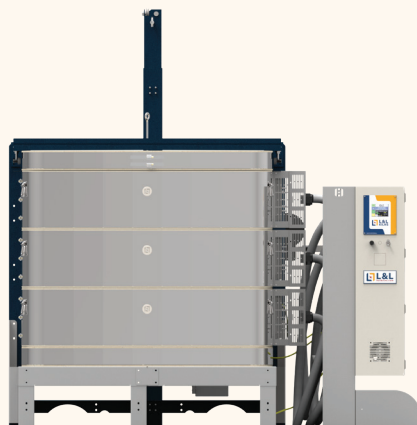

- **Temp Rating: Cone 10**
- **Volume: 14.5 Cubic Feet**
- **Brick Thickness: 3" Brick**
- **Inside: 30.50W x 27H x 30.50D**
- **Capacity: Approx 108 Bowls (6" Diam x 3" H)**

	<b>BRAND</b>	<b>MODEL</b>	<b>CU FT</b>	<b>MAX CONE</b>
Easy-Fire <b>E23T-3</b> 6.7 CU FT CONE 10  School-Master <b>SM23T-3-A</b> 6.7 CU FT CONE 6	SKUTT	KM1027-3	6.40	10
	PARAGON	TNF24-3	7.10	10
	OLYMPIC	2327E	7.00	8
	CRESS	E27	7.00	10
	EVENHEAT	RM II 2329	7.50	8
	AMACO	EX-270SF	7.00	10
Easy-Fire <b>E28S-3</b> 6.8 CU FT CONE 10	SKUTT	KMT-1218	6.6	10
	OLYMPIC	2818HE	6.67	10
	CRESS	ET2818-208	6.6	10
	EVENHEAT	HF 2918	7	10
	AMACO	EX-1266SF	6.6	10
	CONE ART	2818D	6.66	10
Easy-Fire <b>E28M-3</b> 8.5 CU FT CONE 10	SKUTT	KM1222-3	8.10	10
	PARAGON	TNF27-3	8.11	10
	OLYMPIC	2823HE	8.34	10
	AMACO	EX-381SF	8.10	10
	JEN-KEN	AF 2431	8.11	8
	EVENHEAT	RM II 2922	8.70	8
	CONE ART	2822D	8.33	10
Easy-Fire <b>E28T-3</b> 10.2 CU FT CONE 10	SKUTT	KM1227-3	9.90	8
	PARAGON	TNF28-3	10.57	5
	OLYMPIC	2827E	10.00	8
	CRESS	ET28	9.92	10
	JEN-KEN	AF 2829 3"	10.33	8
	EVENHEAT	RM II 2929	11.30	8
	CONE ART	BX-2827D	10.00	10
eQuad-Pro <b>EQ2827-3</b> 10.2 CU FT CONE 10	SKUTT	KM1227-3PK	9.90	10
	PARAGON	VIKING-28	10.57	10
	OLYMPIC	2827HE	10.00	10
	EVENHEAT	HF2927	10.50	10
	AMACO	EX-1099SF	9.92	10
Front-Loading <b>eFL2635</b> 13.7 CU FT CONE 10	PARAGON	DRAGON	9.00	10
	OLYMPIC	FL12E	12.00	10

# Unparalleled Safety

## Features & Highlights of L&L Kilns

Durable, Safe, Efficient

Features	L&L Kilns	Other Kiln Brands
<b>Integrated Vent System</b> <i>Attached Directly to the Kiln Stand</i>	<input checked="" type="checkbox"/>	Vent Box, Supported From Floor, Can Come Loose
<b>Hard Ceramic Element Holders</b>	<input checked="" type="checkbox"/>	Routed Into Fragile Firebrick, Element Changes Can Cause Brick Damage
<b>Easy Access Control Panel</b> <i>Self-Supporting for Solo Maintenance</i>	<input checked="" type="checkbox"/>	Often Difficult To Work On, Requires An Expert
<b>Fully Supported Stand</b>	<input checked="" type="checkbox"/>	Typically Are Thin Gauge With No Center Support
<b>Safety Guides</b>	<input checked="" type="checkbox"/>	<input checked="" type="checkbox"/>

### Ceramic Element Holders Protect Your Brick

Only On L&L Kilns



# Reduced Costs

## Maintenance & Time Savings

Features	L&L Kilns	Other Kiln Brands
<b>Hard Ceramic Element Holders</b> <i>Protect Your Elements and Increase Longevity</i>	<input checked="" type="checkbox"/>	Not Available
<b>Protected Thermocouples</b> <i>Protect From Loading Damage</i>	<input checked="" type="checkbox"/>	Not Available
<b>Pin-Free Elements</b> <i>Save Time &amp; Brick Integrity</i>	<input checked="" type="checkbox"/>	Time Consuming & Damages Brick
<b>Quick Element Changes</b> <i>Save Time &amp; Money</i>	<input checked="" type="checkbox"/>	Requires More Care & Expertise
<b>Warranty Included</b> <i>With Purchase</i>	3-5 Year	3 Month - 2 Year
<b>Thermocouples Included</b> <i>In Warranty</i>	<input checked="" type="checkbox"/>	Varies

# Ventilation

**PRO TIP:** Install a room thermometer approximately 6 ft away from the kiln and 6ft off the floor. The room temperature should be 90° F or less when firing.

### VENTING KILNS: WHY AND HOW?

Cracking the kiln lid for manual venting is outdated and can be hazardous. Firing clay and glazes produces fumes like carbon, carbon monoxide, sulphur, and water vapor. Powered kiln vents are crucial to safeguard your kiln and pottery, removing these fumes efficiently.

### THE VENT-SURE DOWNDRAFT VENT

Unlike other systems, this vent **attaches directly to the kiln stand**. It also enhances kiln uniformity, extends element life, and improves glaze colors by maintaining a vacuum for fumes and keeping the motor away from kiln heat.

### ROOM HEAT VENTILATION MATTERS

In addition to kiln venting, a room vent or window is key. Aim for 10-25 times the kiln's cubic feet per hour.

### CONTROL YOUR VENTING WITH A VENT CONTROL

Opt for our vent control system to manage venting during the firing process. Most fumes are produced at specific times. A vent control allows you to minimize air vented from the kiln and room until specific times in the firing cycle.

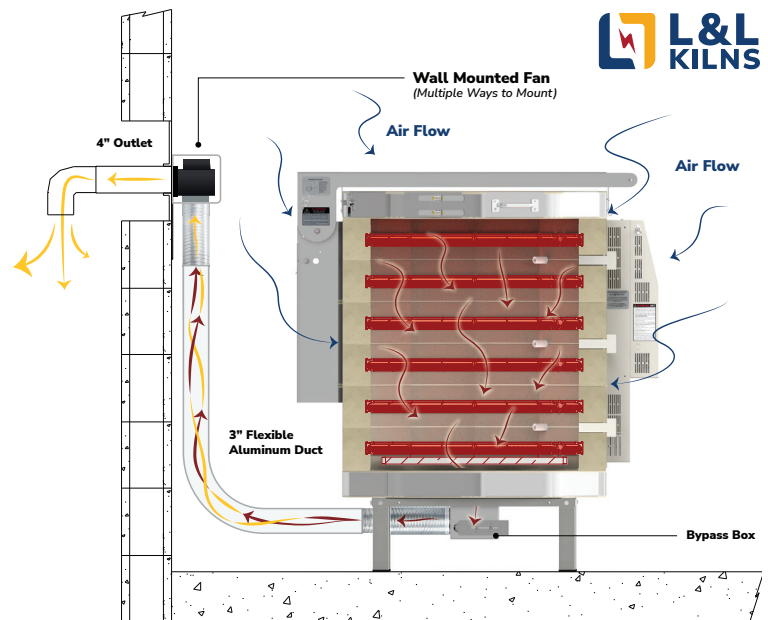

**Vent-Sure Downdraft Vent System**

**Vent Box Attached To Stand**

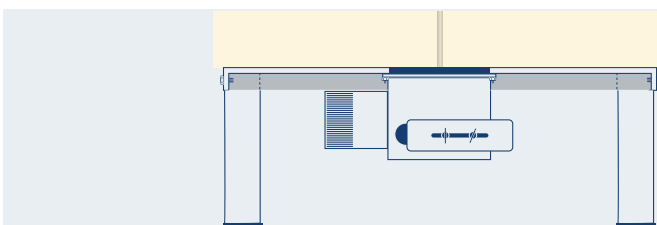

**Vent Box Supported From Floor**

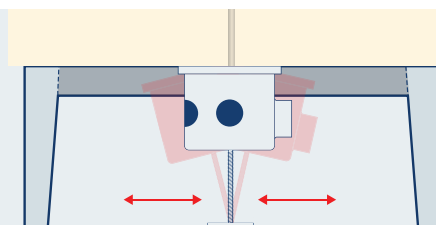

**Top View**



**L&L Kiln Stands**

Full center- kiln base support with integrated bolts for direct mounting vent bypass box to the kiln stand. Adjustable slide allows for airflow control.

**Other Brands**

Stands typically have no center. Vent is supported by a single foot that needs the floor for support. Any movement can release the seal.

**Top View**



## Maintenance & Durability



### CONSIDER MAINTENANCE COSTS

Opt for a kiln designed for easy maintenance. Schools can save time and money due to L&L Kilns unique durability and maintenance features because our kilns are designed for non-experts to maintain. Schools can find savings without the high cost of scarce kiln repair technicians.

### COMMON ISSUES IN OTHER KILNS

In most electric kilns, elements in soft firebrick grooves deteriorate over time. Pins, often used for support, can damage the kiln. A single mishap with a kiln shelf can permanently harm the element groove.

### PINS AMPLIFY ISSUES

Pins, expanding and contracting differently from brick, worsen firebrick fractures.

### L&L SOLUTIONS

L&L's hard ceramic element holders extend kiln life by safeguarding firebrick during changes and accidents. No pins are needed, allowing elements to expand freely, reducing strain and extending their life. Element changes are quick and require no special tools, with no kiln disassembly or difficult crimping.

#### Ceramic Element Holders



Protect Your Brick

#### No Element Pins



Long-Lasting, Clean Interior

#### Dense Ceramic Element Channels



Increase Radiating Surface Of Elements

# Installation Checklist

Fillable Form

See [hotkilns.com](http://hotkilns.com) for all features and options

## Voltage & Power

### USA VOLTAGE

Kilns are in 240 or 208 volts, single/three-phase. Household voltage is 240V single phase; institutions may have 208V, 480V, or three-phase. Confirm with an electrician.

### ENERGY SAVINGS?

No savings for different voltages/phases.

### 480V MODELS

L&L offers eFL, DaVinci, and Easy-Load kilns in 480V.

### WRONG KILN VOLTAGE = IMPROPER OPERATION RESULTS

A 240V kiln loses 25% on 208V; a 208V kiln on 240V draws excess power, tripping the breaker. If you mistakenly order the wrong voltage or phase, replacing the elements and power cord is a straightforward process on an L&L kiln.

### INTERNATIONAL VOLTAGES

Outside the USA, it's typically 220V single-phase or 380V three-phase. L&L provides special elements for both at no extra cost, and all models work on 50 or 60 Hz.

VOLTS \_\_\_\_\_

PHASE \_\_\_\_\_ (single vs three phase)

CIRCUIT BREAKER \_\_\_\_\_ AMPS

DISTANCE FROM BREAKER \_\_\_\_\_ Feet

See each kiln's electrical specs to see which plug is standard to your kiln:

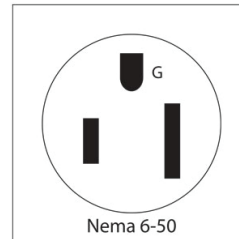

Nema 6-50

Typical Single Phase  
50 Amp Cord

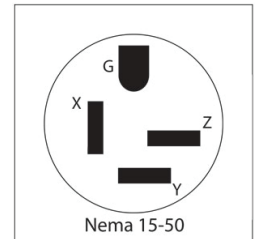

Nema 15-50







Typical Three Phase  
50 Amp Cord

## Kiln Size Needed

Determine Kiln Capacity for School Projects

[Detailed Description Here](http://hotkilns.com/choosing-school-kiln)  
[hotkilns.com/choosing-school-kiln](http://hotkilns.com/choosing-school-kiln)



Average Project Size	Number of Students	Firings Per Week					Kiln Sizes
 <b>(4 in x 4 in x 6 in)</b> <b>1728 in</b>	 = 1.3 Cubic Feet <b>48 Students</b> between two classrooms 48 x 1.3 per student = 64 cu ft	<b>4 Firings Per Week</b> 64/4 = 16 cu ft per firing					<u>16 cu ft per firing</u> <b>Option A:</b> One - e23T-3 = 6.7 cu ft One - e28T-3 = 10.2 cu ft  <b>Option B:</b> Two- e28M-3 = 8.5 cu ft
		Mon 	Tues 	Wed 	Thur 	Fri	

# Installation Checklist

Fillable Form

CSI Specifications:

[hotkilns.com/support/pdfs/sample-csi-specifications](http://hotkilns.com/support/pdfs/sample-csi-specifications)



## SPACE CONSIDERATIONS

CLEARANCES, LOADING & OPERATING

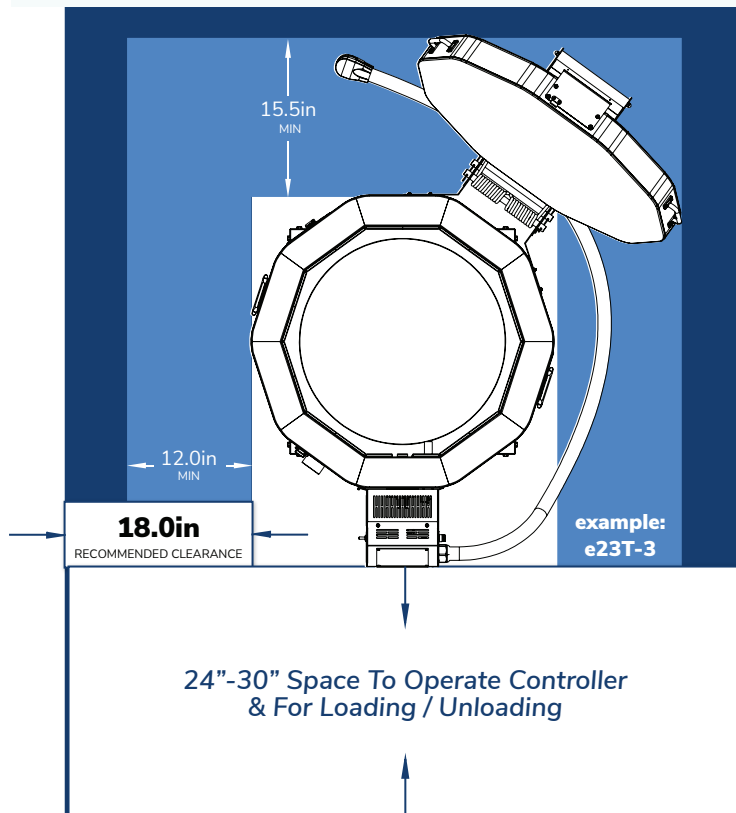

## Read CSI Specifications

- CSI specification outlines the requirements for kilns in school facilities, emphasizing safety and compliance. It covers design, materials, quality assurance, product specifications, and installation guidelines. The document highlights the importance of proper examination, preparation, and cleaning for optimal performance and longevity of the equipment.

## Child Safety

- Children will be protected from the hot kiln.
- Kiln room that locks or a secure designated space.
- Post Signage  
"Hot Kiln - DO NOT TOUCH"  
"No Students Allowed", etc.
- If possible, "Caution" floor tape to map out a safe area.

## Heat Safety

- Recommended 18" from any wall ( 12" MIN)
- Kiln room floor is non-flammable
- Dedicated "Class C" fire extinguisher
- Sprinkler system for the kiln room (Optional)
- 24"-30" clearance for controls & loading

## Ventilation

- Room fan or HVAC sized for the heat of kiln  
(See [hotkilns.com/calculate-venting](http://hotkilns.com/calculate-venting))
- Downdraft Vent to remove fumes



**L&L Kiln Mfg Inc**  
505 Sharptown Rd  
Swedesboro, NJ 08085

**Toll Free:** 800-750-8350  
**Phone No:** (856) 294-0077  
**Email:** [info@hotkilns.com](mailto:info@hotkilns.com)