

DaVinci

Top-Loading Square & Rectangular Kilns

This is a heavy production kiln for production potters, tile makers and industry. It has a stronger shape than an oval kiln.

- Square & Rectangular kilns are perfect for some types of work (like tiles) and allow larger volume
- Plug-in sectional construction makes DaVinci kilns very flexible. They can be easily taken apart and expanded or reduced in size
- Hard Ceramic Element Holders protect brick and make element changes fast and easy
- Dynamic Zone Control keeps temperatures uniform throughout kiln
- Remote Floor Standing Panel protects electronics and makes servicing easy
- Protected Thermocouples
- Spring-Assist counterbalanced lid makes loading easy
- Super-Strong welded steel stand supports heavy loading
- Customize to meet your exact needs.
Every kiln is built to order

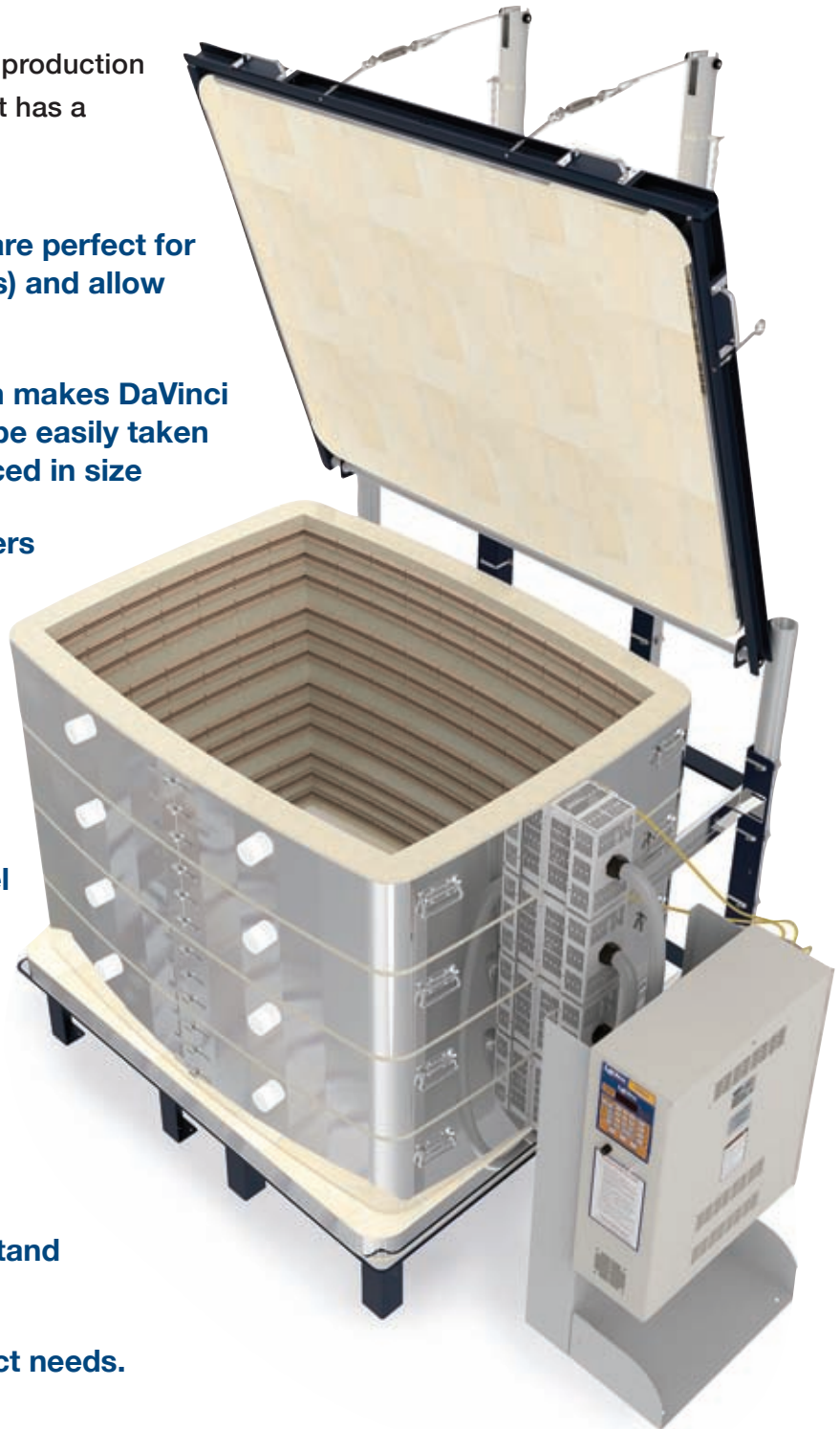

Unique L&L Features with Lasting Benefits

CONE 10 RATING FOR ALL MODELS

Cone 10, 2350°F, 1290°C

3" K23 FIREBRICK INSULATION

3" K23 firebrick for all models.

PATENTED CERAMIC ELEMENT HOLDERS

Protect brick from loading damage, keep elements from falling out of grooves, make changing elements easy, and optimize heat transfer to load. Kiln lasts longer! No pins. (hotkilns.com/ceramic-holders)



BRICK COATING FOR DURABILITY

Proprietary reflective brick coating. This helps firebrick stay strong on the surface, helps prevent dusting on your work, and keeps the kiln clean inside. (hotkilns.com/reflective-coating)

HEAVY-DUTY LARGE ELEMENTS

Heavy-duty. Three elements per section. *Quad elements, which increase the element wire by having four rows of elements per section, are optional on all models. See Page 7.*

THE ULTIMATE SECTIONAL KILN

Sectional kiln construction makes DaVinci kilns easy to move, set up and disassemble for maintenance or for loading. Sections are completely separate from the control panel. Each section has its own plug that plugs into a special receptacle in the control panel. Bottom is reversible.

(hotkilns.com/sectional-davinci)

LID BRICK IS SECURED WITH CLIPS

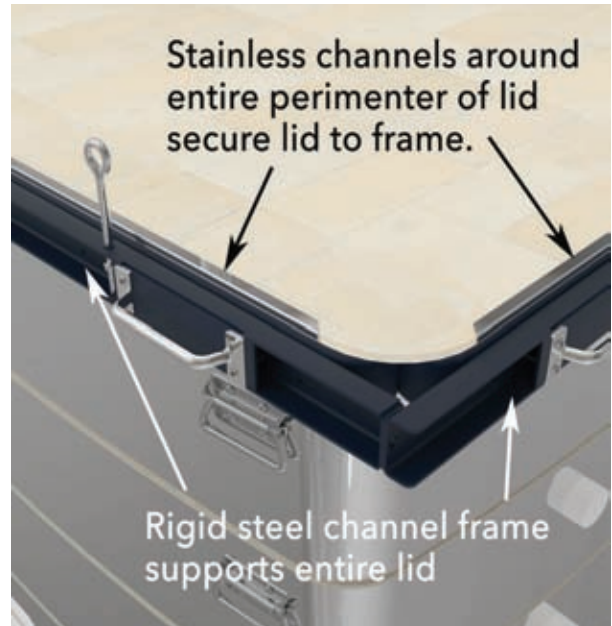

(hotkilns.com/davinci-lid)

EXTRA CASE CLAMPS

Stainless worm gear case clamps keep case together and allow for adjustment over time. Three per 9" section, Two on the top and bottom. (hotkilns.com/case-clamps)

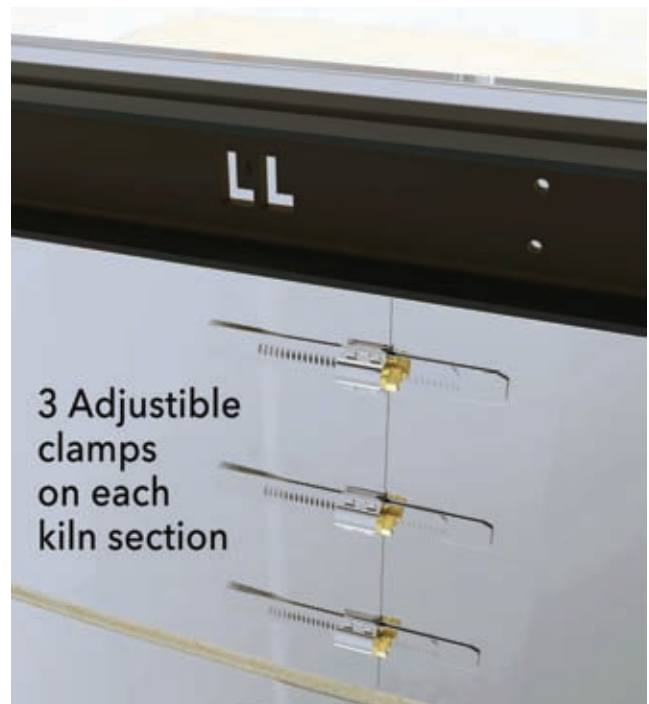

SPRING COUNTERBALANCED HINGE



HEAVY-DUTY FULL-SUPPORT STAND

(hotkilns.com/full-stand)

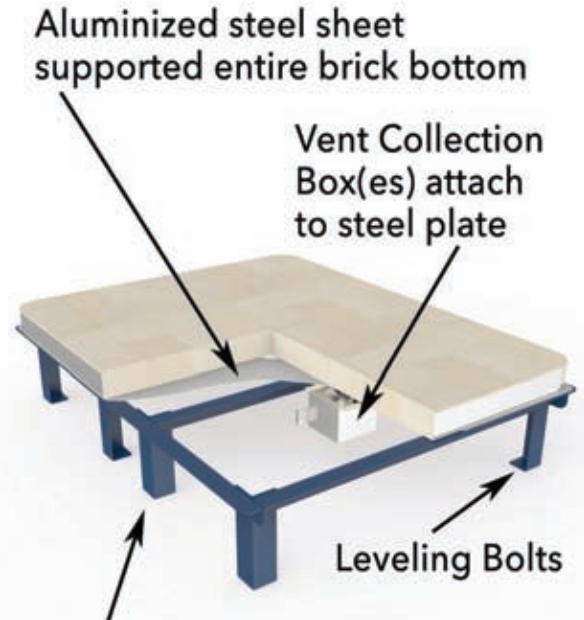

Welded heavy-gauge stand is powder-coated

Vent-Sure Collection Boxes (Two vents are recommended for models over 20 cubic feet)

SOLID PEEPHOLE PLUGS

Solid (non-fragile) ceramic plug with heat-locked mushroom head. 1" diameter full-view non-tapered. (hotkilns.com/peephole-plugs)



SEPARATE COOL-FIRING CONTROL PANEL



All controls and components are mounted in a separate control panel that floor mounted. Cords from the kiln sections plug into the panel. There is an air space between the panel and the kiln which keeps the controls cool - which is critical for long term health of the electronics. (hotkilns.com/davinci-panel)

MERCURY FREE RELAYS

Mercury free relays are standard. See Page 10 for optional electronic SSRs for extra long element life and quiet operation.

EASY MULTI-PROGRAM DYNATROL



The time-tested DynaTrol with 4 Easy-Fire programs, 6 Vary-Fire programs, PreHeat, Delay, Program & Segment Review, and Diagnostics. **Optional Genesis control (see page 8) features touch screen and free**

Wifi App for monitoring kiln. (hotkilns.com/dynatrol)

DYNAMIC ZONE CONTROL

This is a *standard* feature with either a DynaTrol or touch-screen Genesis control. The control separately measures temperatures in the bottom, middle, and top of the kiln and automatically adjusts the heat of two or three zones during the firing. Kiln temperatures are automatically equalized to within 1/2 cone or better. Zone control automatically compensates for many loading issues and element resistance changes. Additionally, L&L kilns are fundamentally uniform because the element holders radiate the heat more evenly. (hotkilns.com/zone-control)

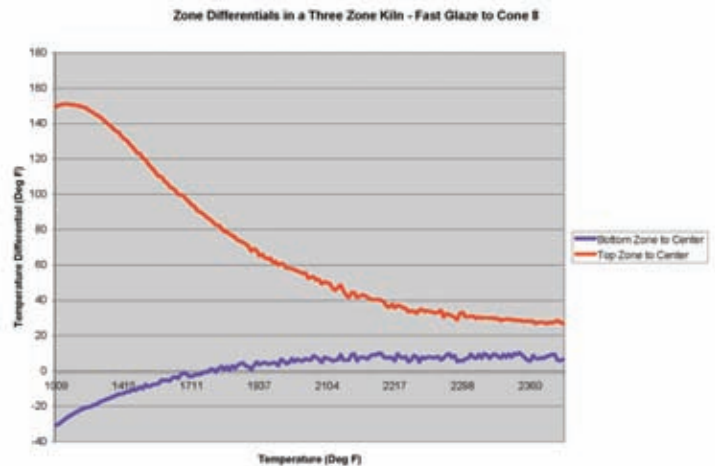

CERAMIC ELEMENT CONNECTIONS



Proprietary all-ceramic element connection block makes changing elements easy. Terminal hardware allows you to get good contact with the element with minimal effort. (hotkilns.com/ceramic-terminal)



HEAVY-GAUGE TYPE K THERMOCOUPLES PROTECTED WITH CERAMIC TUBES

Type K 8 gauge thermocouples are protected by ceramic protection tubes. (hotkilns.com/protected-thermocouples)



FOUR CHEST HANDLES PER KILN SECTION



Chest Handles make the sections easy to lift.

CORROSION RESISTANT CONSTRUCTION

Stainless steel wrapped around brick. All stainless screws on case. Vent parts are stainless steel or aluminum. Stand and hinge are powder-coated welded steel. Control box is powder coated steel. (hotkilns.com/case)

DIRECT WIRING

All DaVinci kilns are direct wired.

COMPLETE VISUAL INSTRUCTIONS

No one has a better or more complete instruction manual. Our visual instructions address the needs of the artist, the installer, and the repair person. You get a fully illustrated operation and service manual. Many instructional videos are available. (hotkilns.com/videos)

L&L KILNS ARE EASY TO TROUBLESHOOT

Open up any L&L kiln control panel and see how easy it is to check amps, element resistance, and voltage. No other kiln can be serviced as quickly, easily, or inexpensively as an L&L kiln.

THREE-YEAR WARRANTY

See hotkilns.com/warranty. Email, web and phone support.

IN-DEPTH SUPPORT

One customer said: "I am truly impressed with your website, it is more than informative and your products are well designed. The fact that all the information, including repair manuals, are listed, speaks well of your dedication to customer service." Our website has thousands of pages of technical help - all easily searchable - plus we provide expert support with phone and email.

SUSTAINABLE MANUFACTURING

We use solar energy as our primary energy source.

SUPERIOR PACKAGING

Kilns are securely packed with tubes of foam molded to the kiln. Kilns are shipped in skidded cartons or wooden crates depending on their size.

MET UL499 LISTING



c-MET-us listed to UL499 standards assures highest safety standards. (hotkilns.com/met)



Stop worrying about loading your kiln! Load with confidence. You won't damage the fragile firebrick, touch dangling elements, or damage the protected thermocouples.

Elements can be changed in minutes without damaging the firebrick. NO PINS!

Optional Kiln Furniture, Fiber Tops, & Quad & APM Element Options

CONE 11 FURNITURE KITS

Shelves are high alumina cone 11 shelves. Each post kit includes six each 1/2", 1", 2", 4", 6" and 8" high square (1.5" x 1.5") cordierite posts. Some kits come with two post kits (see specification pages). All furniture kits include one pair heat-resistant gloves. (hotkilns.com/kiln-furniture)

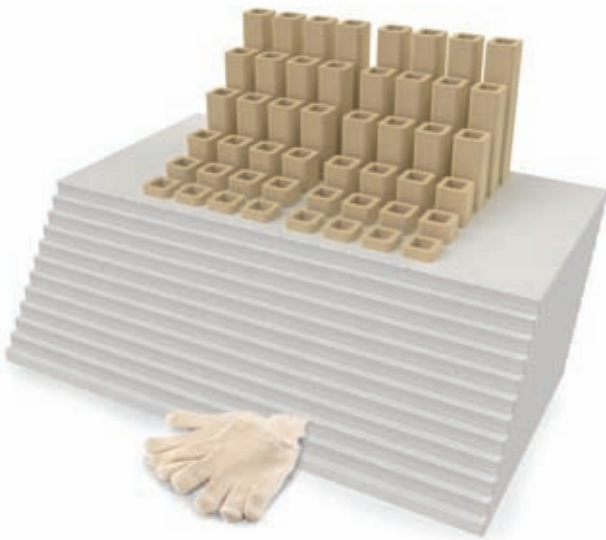

QUAD ELEMENT DESIGN

The combination of 1/2" diameter element coils, the doubled surface area of the Quad element design, and superior heat transfer of L&L's patented ceramic element holders, make this the best element system in the world today. (hotkilns.com/quad-option)



APM ELEMENTS

Special sintered alloy provides the ultimate in element life. The special sintered alloy inhibits grain growth and resistance change in the elements. (hotkilns.com/apm)

OPTIONAL FIBER TOP

These are ideal for T3400 kilns and X3200 kilns used for tough industrial applications. The lid firebrick is replaced with ceramic fiber modules. 2600°F ceramic fiber is folded and formed into 4" thick modules that have an alloy support system inside. The internal support of the module is bolted to a metal frame that matches the normal metal frame that we use in the firebrick lid. These lids will never crack or spall and will last indefinitely. The ceramic fiber is rated to a higher temperature than the kiln rating so there is no concern about shrinkage of the fiber.



Warning: Refractory ceramic fiber has hazards associated with its use. The RCF fiber is only intended for industrial use in production facilities.

Genesis Touch Screen Control with App

GENESIS TOUCH SCREEN CONTROL

The Genesis control includes a touch screen interface and WIFI connectivity added to the proven software of the DynaTrol. More programming options and memory. Free App available to monitor kiln via WiFi. (hotkilns.com/genesis)



The Genesis control fits right into the control box to replace the DynaTrol. That means you can upgrade anytime!

GENESIS FEATURES

- Touch-screen intuitive technology for easy user interface.
- Easy-to-follow screen descriptions.
- Different user-interface levels, which can be set to match the user's firing knowledge.
- Graphical display of the firing process right at the controller. This means you can graph the firing in real time and compare the program with actual results.
- Glass programs included.
- Store up to 30 custom user programs.
- Up to 32 segments per program.
- Ability to make adjustments during a firing such as add segments, add temperature, and skip segments.
- Built in diagnostics testing
- Alarm
- Error Codes
- WiFi enabled for easy software updating.
- Included Phone App allows you to monitor kiln operation remotely (with no subscription fee).



See a graph of your firing before you fire, while you fire and after you fire.

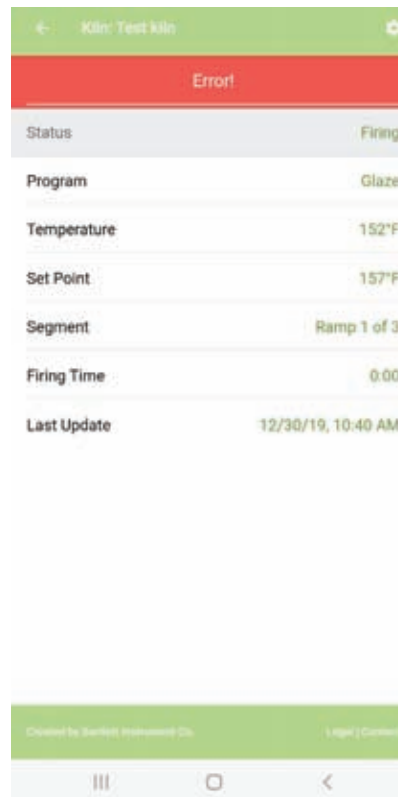

This shows the view you get on your phone with the Kiln Aid Phone app. Simply download the Kiln Aid phone app from your Google Play Store or Apple App Store, add your kiln, and begin monitoring as your kiln progresses through a firing. See temperatures, where you are in a program cycle, what program you are firing and error notifications.

Ventilation Options & Accessories

DOWNDRAFT VENT SYSTEM

Vent-Sure downdraft vent vents fumes from kiln out of room and away from kiln. (hotkilns.com/vent)

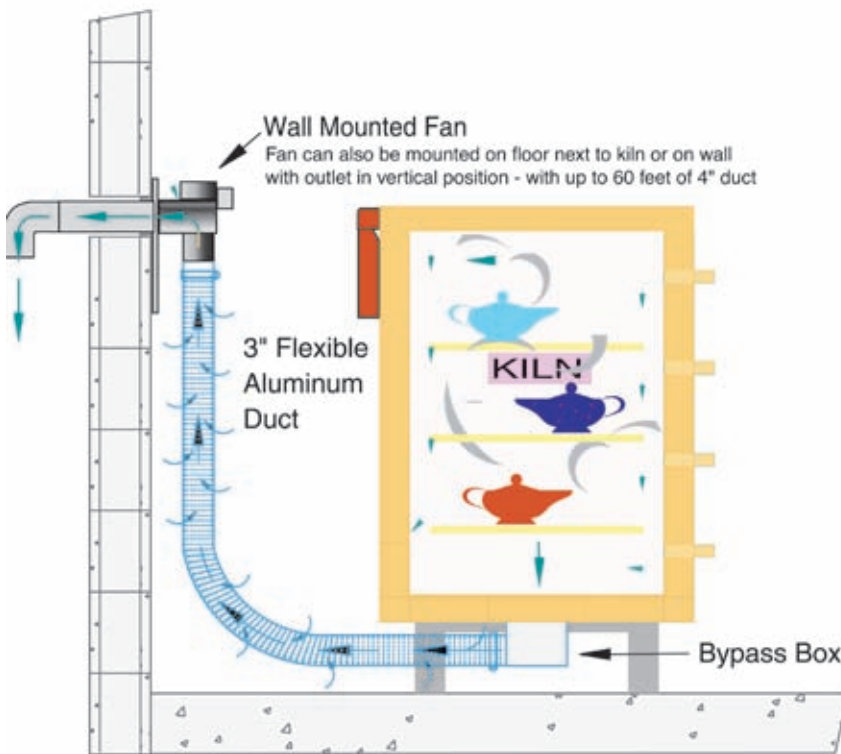

VENT-SURE FEATURES

- Downdraft venting pulls air down to bottom of kiln
- Improves temperature uniformity inside the kiln
- Powerful 130 CFM fan motor, typically mounted on wall, allows fumes to be under vacuum in your studio
- The strong fan motor helps overcome static pressure in long exhaust lines. The duct may be up to 60 feet in length, and include up to four 90° bends
- 120 volts with on/off switch on cord (240 volts available)
- 15 foot long flexible aluminum duct
- Bypass collection box mounted on kiln allows adjustment of venting.
- Fan motor, mounted away from the kiln, stays cool and no vibration is transmitted to the kiln
- The included Multi-Mounting Bracket allows you to mount the vent on the floor or, alternately, to mount the vent on a wall so that the output of the vent is pointing up.
- Three-year Limited Warranty
- c-MET-us Listed to UL499 standards for use on c-MET-us L&L Kilns



VENT CONTROL

Allows vent to be controlled with an event switch in the DynaTrol or Genesis. (For use with one kiln.) (hotkilns.com/vent-control)



HOW MANY VENTS?

We recommend one vent for kilns that are 25 cubic feet or less and two vents for kilns that are 25 cubic feet or more. See the specification pages for cubic foot specifications.

More Control & Power Options

TYPE S THERMOCOUPLES

The best thermocouple for constant high fire applications. No thermocouple drift. Priced per thermocouple. Note that kilns with four or more sections still only have a three zone control.

(hotkilns.com/type-s)

PYROCIL SHEATHED THERMOCOUPLES

For greater sensitivity to temperature change. Use below 2200°F for sensitivity (glass is a good example). Priced per thermocouple. These are useful for sensitive industrial applications.

(hotkilns.com/pyrocil-tc)

KISS SOFTWARE

Kiss (kiln interface software system) connects up to 50 DynaTrol controllers to a personal computer running Windows. Monitor and control kiln remotely. For the DynaTrol only. (hotkilns.com/kiss)

SOLID STATE RELAYS

Industrial Grade Solid State Relays are quiet and result in longer element life because the switching time is so fast the elements don't expand and contract as much. The whole system includes extra large heat sinks, special fast acting fuses, cooling fan and extra safety relays. (hotkilns.com/ssr)

HIGH LIMIT BACK UP CONTROL

Bartlett High Limit Control with latching relay acts as a back up to the main control. If the main control fails for any reason then this acts as a "back stop" and shuts the kiln down.

(hotkilns.com/high-limit)

BACK UP CONTACTORS

Actuated by the High Limit Back Up Digital Control, back up contactors are completely redundant power contactors so that if one or more contactors fail in a closed position, then the kiln still cannot climb above the High Limit set point. (hotkilns.com/high-limit)

120 VOLT POWER SUPPLY

If there are problems with short power outages, voltage spikes, voltage drops, or excessive environmental line noise, this can cause unpredictable behaviour in the electronic control. With this option the control is powered by a separate 120 volt line (with a standard 6 foot long cord) and that voltage is filtered through an EMI (Electrical Magnetic Interference) noise filter. (hotkilns.com/noise)

NEMA1 CONTROL PANEL



These are typically used for 480 volt models. They include integrated panel stand legs.

480 VOLT OPTION

Available on all DaVinci kilns. The typical wiring is to use a floating Wye system and run the elements on 277 volts. However, on the quad models there are two 240 volt elements in series. The amperage ratings of those models are slightly different. Check on the website for details.

Pull-Apart Option

“PULL-APART” OPTION FOR SCULPTURE AND INDUSTRY

Includes floor mount stand for control panel, lift off lid with extra handles but no hinge. This option allows the entire kiln to be dismantled to make it easy to load large sculptural pieces. The kiln sections are unplugged and then taken off one at a time. You can order a hinge as well but the hinge makes the kiln harder to take apart.



Custom cross sections and heights available

Electrical Specifications for X2300 Series (USA)

Standard Models								High Powered Models				
Model Number	Part Number	Volt/Phase	Watts	Amps	Wire Size	Fuse Size	Model Number	Part Number	Watts	Amps	Wire Size	Fuse Size
XB2318-D-240	K-X-2318/31	240/1P	8,936	37.2	6 ga	50 *						
XB2318-D-240-3P	K-X-2318/32	240/3P	8,936	32.2	6 ga	50 *						
XB2318-D-208	K-X-2318/21	208/1P	8,936	43.0	6 ga	60						
XB2318-D-208-3P	K-X-2318/22	208/3P	8,936	37.2	6 ga	50						
XB2318-D-480-3P	K-X-2318/62	480/3P	8,936	10.8	14 ga	15						
XB2318-D-480-3P-QD	K-X-231N/62	480/3P	8,936	16.1	12 ga	25						
X2327-D-240	K-X-2327/31	240/1P	11,704	48.8	4 ga	70 *	XB2327-D-240	K-X-232B/31	13,404	55.9	4 ga	70 *
X2327-D-240-3P	K-X-2327/32	240/3P	11,704	28.2	8 ga	40 *	XB2327-D-240-3P	K-X-232B/32	13,404	32.2	6 ga	50 *
X2327-D-208	K-X-2327/21	208/1P	11,704	56.3	3 ga	80 *	XB2327-D-208	K-X-232B/21	13,404	64.4	2 ga	90
X2327-D-208-3P	K-X-2327/22	208/3P	11,704	32.5	6 ga	50 *	XB2327-D-208-3P	K-X-232B/22	13,404	37.2	6 ga	50
X2327-D-480-3P	K-X-2327/62	480/3P	11,704	14.1	14 ga	20	XB2327-D-480-3P	K-X-232B/62	13,404	16.1	12 ga	25
X2327-D-480-3P-QD	K-X-232Q/62	480/3P	11,704	14.1	14 ga	20	XB2327-D-480-3P-QD	K-X-232N/62	13,404	16.1	12 ga	25
X2336-D-240	K-X-2336/31	240/1P	15,604	65.0	2 ga	90 *	XB2336-D-240	K-X-233B/31	17,872	74.5	1 ga	100 *
X2336-D-240-3P	K-X-2336/32	240/3P	15,604	43.0	6 ga	60 *	XB2336-D-240-3P	K-X-233B/32	17,872	49.3	4 ga	70 *
X2336-D-208	K-X-2336/21	208/1P	15,604	75.0	1 ga	100 *	XB2336-D-208	K-X-233B/21	17,872	85.9	1 ga	110
X2336-D-208-3P	K-X-2336/22	208/3P	15,604	49.6	4 ga	70 *	XB2336-D-208-3P	K-X-233B/22	17,872	56.8	3 ga	80
X2336-D-480-3P	K-X-2336/62	480/3P	15,604	18.8	12 ga	25	XB2336-D-480-3P	K-X-233B/62	17,872	21.5	10 ga	30
X2336-D-480-3P-QD	K-X-233Q/62	480/3P	15,604	21.5	10 ga	30	XB2336-D-480-3P-QD	K-X-233N/62	17,872	24.6	8 ga	40
X2345-D-240	K-X-2345/31	240/1P	19,505	81.3	1 ga	110 *	XB2345-D-240	K-X234B/31	22,340	93.1	1/0	125 *
X2345-D-240-3P	K-X-2345/32	240/3P	19,505	56.3	3 ga	80 *	XB2345-D-240-3P	K-X234B/32	22,340	64.5	2 ga	90 *
X2345-D-208	K-X-2345/21	208/1P	19,505	93.8	1/0	125 *	XB2345-D-208	K-X234B/21	22,340	107.4	3/0	150
X2345-D-208-3P	K-X-2345/22	208/3P	19,505	65.0	2 ga	90 *	XB2345-D-208-3P	K-X234B/22	22,340	74.4	1 ga	100
X2345-D-480-3P	K-X-2345/62	480/3P	19,505	23.5	10 ga	30	XB2345-D-480-3P	K-X234B/62	22,340	26.9	8 ga	40
X2345-D-480-3P-QD	K-X-234Q/62	480/3P	19,505	28.2	8 ga	40	XB2345-D-480-3P-QD	K-X234N/62	22,340	18.6	12 ga	25

ELECTRICAL NOTES

MET UL499 Listing: All models are c-MET-us listed to UL499 standard.

Cone Rating: All models are rated to Cone 10.

Wiring Diagrams: See the **Electrical Tab** for each kiln model to get the wiring diagram for each voltage.

Power connection: Direct wired.

Elements: All elements are of equal resistance value. Quad elements are the same resistance but longer and thicker.

XB MODELS: XB models have more power than the regular X model kilns. The higher powered XB elements are always used on the XB2318 because of the large ratio of unheated surface area.

(*) Control Panels: In the Fuse Size column if there is an asteric (*) then the kiln gets a Jupiter type kiln mount panel. All other kilns get a floor standing panel. NEMA 1 panel are recommended but not required for 480 volts.

Electrical Specifications for X2300 Series (World)

Standard Models								High Powered Models				
Model Number	Part Number	Volt/Phase	Watts	Amps	Wire Size	Fuse Size	Model Number	Part Number	Watts	Amps	Wire Size	Fuse Size
XB2318-D-220	K-X-2318/41	220/1P	8,936	40.6	6 ga	60						
XB2318-D-380-3PY	K-X-2318/52	380/3PY	8,936	20.3	10 ga	30						
XB2318-D-400-3PY	K-X-2318/82	400/3PY	8,936	19.4	12 ga	25						
XB2318-D-415-3PY	K-X-2318/72	415/3PY	8,936	18.6	12 ga	25						
X2327-D-220	K-X-2327/41	220/1P	11,704	53.2	4 ga	70 *	XB2327-D-220	K-X-232B/41	13,404	60.9	3 ga	80
X2327-D-380-3PY	K-X-2327/52	380/3PY	11,704	17.7	12 ga	25 *	XB2327-D-380-3PY	K-X-232B/52	13,404	20.3	10 ga	30
X2327-D-400-3PY	K-X-2327/82	400/3PY	11,704	17.0	12 ga	25 *	XB2327-D-400-3PY	K-X-232B/82	13,404	19.4	12 ga	25
X2327-D-415-3PY	K-X-2327/72	415/3PY	11,704	16.3	12 ga	25 *	XB2327-D-415-3PY	K-X-232B/72	13,404	18.6	12 ga	25
X2336-D-220	K-X-2336/41	220/1P	15,604	70.9	2 ga	90 *	XB2336-D-220	K-X-233B/41	17,872	81.2	1 ga	110
X2336-D-380-3PY	K-X-2336/52	380/3PY	15,604	35.5	6 ga	50 *	XB2336-D-380-3PY	K-X-233B/52	17,872	40.6	6 ga	60
X2336-D-400-3PY	K-X-2336/82	400/3PY	15,604	33.9	6 ga	50 *	XB2336-D-400-3PY	K-X-233B/82	17,872	38.9	6 ga	50
X2336-D-415-3PY	K-X-2336/72	415/3PY	15,604	32.5	6 ga	50 *	XB2336-D-415-3PY	K-X-233B/72	17,872	37.2	6 ga	50
X2345-D-220	K-X-2345/41	220/1P	19,505	88.7	1/0	125 *	XB2345-D-220	K-X-234B/41	22,340	101.5	3/0	150
X2345-D-380-3PY	K-X-2345/52	380/3PY	19,505	35.5	6 ga	50 *	XB2345-D-380-3PY	K-X-234B/52	22,340	40.6	6 ga	60
X2345-D-400-3PY	K-X-2345/82	400/3PY	19,505	33.9	6 ga	50 *	XB2345-D-400-3PY	K-X-234B/82	22,340	38.9	6 ga	50
X2345-D-415-3PY	K-X-2345/72	415/3PY	19,505	32.5	6 ga	50 *	XB2345-D-415-3PY	K-X-234B/72	22,340	37.2	6 ga	50

ELECTRICAL NOTES

MET UL499 Listing: All models are c-MET-us listed to UL499 standard.

Cone Rating: All models are rated to Cone 10.

Wiring Diagrams: See the **Electrical Tab** for each kiln model to get the wiring diagram for each voltage.

Power connection: Direct wired.

Elements: All elements are of equal resistance value. Quad elements are the same resistance but longer and thicker.

XB MODELS: XB models have more power than the regular X model kilns. The higher powered XB elements are always used on the XB2318 because of the large ratio of unheated surface area.

(*) Control Panels: In the Fuse Size column if there is an asteric (*) then the kiln gets a Jupiter type kiln mount panel. All other kilns get a floor standing panel.

Dimension & Weight Specifications for X2300 Series

Model Number	Inside Height	Cubic Feet	Furniture Kit	Furniture Kit Part No.	Outside Dimensions	Shipping Dimensions (with Kit)	Ship Weight Kiln Only	Ship Weight Kiln + Kit
XB2318-D	18"	5.0	4 shelves, 1 post kit	H-X-K318/00	43" W x 74" H x 41" D	1 crate: 44" W x 46" H x 48" D 1 crate: 45" W x 84" H x 48" D	555 lbs	625 lbs
X2327-D	27"	7.6	6 shelves, 1 post kit	H-X-K327/00	43" W x 87" H x 41" D	1 crate: 44" W x 54" H x 48" D 1 crate: 44" W x 93" H x 48" D	640 lbs	730 lbs
X2336-D	36"	10.1	8 shelves, 2 post kits	H-X-K336/00	43" W x 96" H x 41" D	1 crate: 44" W x 64" H x 48" D 1 crate: 44" W x 93" H x 48" D	800 lbs	915 lbs
X2345-D	45"	12.6	10 shelves, 2 post kits	H-X-K345/00	43" W x 105" H x 41" D	1 crate: 44" W x 54" H x 48" D 1 crate: 44" W x 93" H x 48" D 1 crate: 44" W x 42" H x 48" D	920 lbs	1,055 lbs
METRIC DIMENSIONS (CM, LITERS & KG)								
XB2318-D	45.7	143 L	4 shelves, 1 post kit	H-X-K318/00	109 W x 188 H x 104 D	1 crate: 112 W x 117 H x 122 D 1 crate: 115 W x 214 H x 122 D	252 KG	284 KG
X2327-D	68.6	215 L	6 shelves, 1 post kit	H-X-K327/00	109 W x 221 H x 104 D	1 crate: 112 W x 138 H x 122 D 1 crate: 112 W x 237 H x 122 D	291 KG	332 KG
X2336-D	91.4	286 L	8 shelves, 2 post kits	H-X-K336/00	109 W x 244 H x 104 D	1 crate: 112 W x 163 H x 122 D 1 crate: 112 W x 237 H x 122 D	363 KG	416 KG
X2345-D	114.3	357 L	10 shelves, 2 post kits	H-X-K345/00	109 W x 267 H x 104 D	1 crate: 112 W x 138 H x 122 D 1 crate: 115 W x 237 H x 122 D 1 crate: 112 W x 107 H x 122 D	418 KG	479 KG

DIMENSION & SHIPPING NOTES

Cross section of Inside: Approximately 22" wide by 22" deep. (56 cm by 56 cm)

Hearth Setting Area: 20" wide by 20" deep. (50.8 cm by 50.8 cm)

Recommended Minimum Space Requirements: 75.6" wide by 70.8" deep (192 cm by 180 cm)
(See General Dimension Diagram for details).

MORE: See each model page on hotkilns.com to download PDF General Dimension Drawings for more outside and inside dimensions, minimum space requirements, BTU ventilation requirements, and kiln weight. See the Shipping Tab on the model page for complete shipping dimension and shipping weight information.

Moving and installation: The kiln comes assembled but can be quickly disassembled and reassembled to move through any door or up stairs. It comes packed in a skidded carton with secure foam-in-place packaging.

XB2318

Temperature Rating: Cone 10

Volume: 5.0 Cubic Feet

Brick Thickness: 3" Brick

Inside: 22" W x 18" High

Outside Dimensions: 43" W x 74" H x 41" D

Shipping Dim with Vent & Furn Kit: 2 Crates (44" W x 46" H x 48" D & 44" W x 54" H x 48" D)

Ship Weight (Kiln): 555 LBS

Ship Weight (Kiln, Vent & Furn Kit): 625 LBS

FURNITURE KIT FOR XB2318

Part Number: H-X-K318/00

Includes: Four 20" X 10" Rectangular Shelves (3/4" thick), Six Each 1/2", 1", 2", 4", 6", and 8" Square Posts, Heat Resistant Gloves.



X2327

Temperature Rating: Cone 10

Volume: 7.6 Cubic Feet

Brick Thickness: 3" Brick

Inside: 22" W x 27" High

Outside Dimensions: 43" W x 87" H x 41" D

Shipping Dim with Vent & Furn Kit: 2 Crates (44" W x 54" H x 48" D & 44" W x 84" H x 48" D)

Ship Weight (Kiln): 640 LBS

Ship Weight (Kiln, Vent & Furn Kit): 730 LBS

FURNITURE KIT FOR X2327

Part Number: H-X-K327/00

Includes: Six 20" X 10" Rectangular Shelves (3/4" thick), Six Each 1/2", 1", 2", 4", 6", and 8" Square Posts, Heat Resistant Gloves.



X2336

Temperature Rating: Cone 10

Volume: 10.1 Cubic Feet

Brick Thickness: 3" Brick

Inside: 22" W x 36" High

Outside Dimensions: 43" W x 96" H x 41" D

Shipping Dim with Vent & Furn Kit: 2 Crates (44" W x 52" H x 48" D & 44" W x 84" H x 48" D)

Ship Weight (Kiln): 800 LBS

Ship Weight (Kiln, Vent & Furn Kit): 915 LBS

FURNITURE KIT FOR X2336

Part Number: H-X-K336/00

Includes: Eight 20" X 10" Rectangular Shelves (3/4" thick), Twelve Each 1/2", 1", 2", 4", 6", and 8" Square Posts, Heat Resistant Gloves.



X2345

Temperature Rating: Cone 10

Volume: 12.6 Cubic Feet

Brick Thickness: 3" Brick

Inside: 22" W x 45" High

Outside Dimensions: 43" W x 105" H x 42" D

Shipping Dim with Vent & Furn Kit: 3 Crates (44" W x 54" H x 48" D, 44" W x 36" H x 48" D & 44" W x 84" H x 48" D)

Ship Weight (Kiln): 920 LBS

Ship Weight (Kiln, Vent & Furn Kit): 1,055 LBS

FURNITURE KIT FOR X2345

Part Number: H-X-K345/00

Includes: Ten 20" X 10" Rectangular Shelves (3/4" thick), Twelve Each 1/2", 1", 2", 4", 6", and 8" Square Posts, Heat Resistant Gloves.

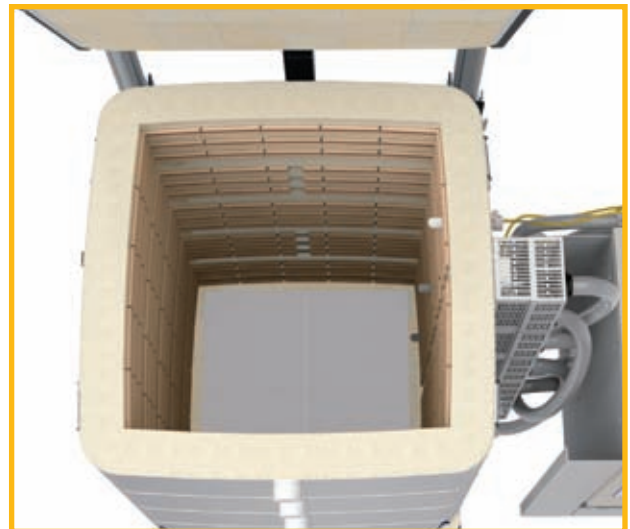

Electrical Specifications for X2800 Series (USA)

Standard Models							Powered Bottom Models				
Model Number	Part Number	Volt/Phase	Watts	Amps	Wire Size	Fuse Size	Part Number	Watts	Amps	Wire Size	Fuse Size
XB2818-D-240	K-X-2818/31	240/1P	11,592	48.3	4 ga	70	K-X-281W/31	15,456	64.4	2 ga	90
XB2818-D-240-3P	K-X-2818/32	240/3P	11,592	41.8	6 ga	60	K-X-281W/32	15,456	41.8	6 ga	60
XB2818-D-208	K-X-2818/21	208/1P	11,592	55.7	4 ga	70	K-X-281W/21	15,456	74.3	1 ga	100
XB2818-D-208-3P	K-X-2818/22	208/3P	11,592	48.3	4 ga	70	K-X-281W/22	15,456	48.3	4 ga	70
XB2818-D-480-3P	K-X-2818/22	480/3P	11,592	20.9	10 ga	30	K-X-281W/22	15,456	20.9	10 ga	30
X2827-D-240	K-X-2827/31	240/1P	14,930	62.2	3 ga	80	K-X-282P/31	18,250	76.0	1 ga	100
X2827-D-240-3P	K-X-2827/32	240/3P	14,930	35.9	6 ga	50	K-X-282P/32	18,250	48.4	4 ga	70
X2827-D-208	K-X-2827/21	208/1P	14,930	71.8	2 ga	90	K-X-282P/21	18,250	87.7	1 ga	110
X2827-D-208-3P	K-X-2827/22	208/3P	14,930	41.5	6 ga	60	K-X-282P/22	18,250	55.8	4 ga	70
X2827-D-480-3P	K-X-2827/62	480/3P	14,930				K-X-282P/62	18,250	24.0	10 ga	30
XB2827-D-240	K-X-282B/31	240/1P	17,388	72.5	1 ga	100	K-X-282W/31	21,252	88.6	1/0	125
XB2827-D-240-3P	K-X-282B/32	240/3P	17,388	41.8	6 ga	60	K-X-282W/32	21,252	56.3	3 ga	80
XB2827-D-208	K-X-282B/21	208/1P	17,388	83.6	1 ga	110	K-X-282W/21	21,252	102.2	3/0	150
XB2827-D-208-3P	K-X-282B/22	208/3P	17,388	48.3	4 ga	70	K-X-282W/22	21,252	65.0	2 ga	90
XB2827-D-480-3P	K-X-282B/62	480/3P	17,388	20.9	10 ga	30	K-X-282W/62	21,252	27.9	8 ga	40
X2836-D-240	K-X-2836/31	240/1P	19,907	82.9	1 ga	110	K-X-283P/31	23,226	96.8	1/0	125
X2836-D-240-3P	K-X-2836/32	240/3P	19,907	54.9	4 ga	70	K-X-283P/32	23,226	65.9	2 ga	90
X2836-D-208	K-X-2836/21	208/1P	19,907	95.7	1/0	125	K-X-283P/21	23,226	111.7	3/0	150
X2836-D-208-3P	K-X-2836/22	208/3P	19,907	63.3	3 ga	80	K-X-283P/22	23,226	76.1	1 ga	100
X2836-D-480-3P	K-X-2836/62	480/3P	19,907	20.7	10 ga	30	K-X-283P/62	23,226	30.0	8 ga	40
XB2836-D-240	K-X-283B/31	240/1P	23,184	96.6	1/0	125	K-X-283W/31	27,050	112.7	3/0	150
XB2836-D-240-3P	K-X-283B/32	240/3P	23,184	63.9	3 ga	80	K-X-283W/32	27,050	76.8	1 ga	100
XB2836-D-208	K-X-283B/21	208/1P	23,184	111.5	3/0	150	K-X-283W/21	27,050	130.0	4/0	175
XB2836-D-208-3P	K-X-283B/22	208/3P	23,184	73.7	1 ga	100	K-X-283W/22	27,050	88.6	1/0	125
XB2836-D-480-3P	K-X-283B/62	480/3P	23,184	27.9	8 ga	40	K-X-283W/62	27,050	34.9	6 ga	50
X2845-D-240	K-X-2845/31	240/1P	24,885	103.7	3/0	150	K-X-284P/31	28,203	117.5	3/0	150
X2845-D-240-3P	K-X-2845/32	240/3P	24,885	71.9	2 ga	90	K-X-284P/32	28,203	71.8	2 ga	90
X2845-D-208	K-X-2845/21	208/1P	24,885	119.6	3/0	150	K-X-284P/21	28,203	135.6	4/0	175
X2845-D-208-3P	K-X-2845/22	208/3P	24,885	82.9	1 ga	110	K-X-284P/22	28,203	82.9	1 ga	110
X2845-D-480-3P	K-X-2845/62	480/3P	24,885	29.9	8 ga	40	K-X-284P/62	28,203	35.9	6 ga	50
XB2845-D-240	K-X-284B/31	240/1P	29,980	120.8	4/0	175	K-X-284W/31	32,845	136.9	4/0	175
XB2845-D-240-3P	K-X-284B/32	240/3P	29,980	83.7	1 ga	110	K-X-284W/32	32,845	83.7	1 ga	110
XB2845-D-208	K-X-284B/21	208/1P	29,980	139.3	4/0	175	K-X-284W/21	32,845	157.9	250 mcm	200
XB2845-D-208-3P	K-X-284B/22	208/3P	29,980	96.5	1/0	125	K-X-284W/22	32,845	96.5	1/0	125
XB2845-D-480-3P	K-X-284B/62	480/3P	29,980	34.9	6 ga	50	K-X-284W/62	32,845	41.9	6 ga	60

SEE PAGE 20 FOR ELECTRICAL NOTES

Electrical Specifications for X2800 Series (World)

Standard Models							Powered Bottom Models				
Model Number	Part Number	Volt/Phase	Watts	Amps	Wire Size	Fuse Size	Part Number	Watts	Amps	Wire Size	Fuse Size
XB2818-D-220	K-X-2818/41	220/1P	11,592	69.7	2 ga	90	K-X-281W/41	15,456	70.3	2 ga	90
XB2818-D-380-3PY	K-X-2818/52	380/3PY	11,592	26.3	8 ga	40	K-X-281W/52	15,456	26.4	8 ga	40
XB2818-D-400-3PY	K-X-2818/82	400/3PY	11,592	25.2	8 ga	40	K-X-281W/82	15,456	25.2	8 ga	40
XB2818-D-415-3P4	K-X-2818/72	415/3PY	11,592	24.2	8 ga	40	K-X-281W/72	15,456	24.2	8 ga	40
X2827-D-220	K-X-2827/41	220/1P	14,930	67.9	2 ga	90	K-X-282P/41	18,250	83.0	1 ga	110
X2827-D-380-3PY	K-X-2827/52	380/3PY	14,930	22.6	10 ga	30	K-X-282P/52	18,250	37.7	6 ga	50
X2827-D-400-3PY	K-X-2827/82	400/3PY	14,930	21.6	10 ga	30	K-X-282P/82	18,250	36.1	6 ga	50
X2827-D-415-3PY	K-X-2827/72	415/3PY	14,930	20.7	10 ga	30	K-X-282P/72	18,250	34.6	6 ga	50
XB2827-D-220	K-X-2827/41	220/1P	17,388	79.0	1 ga	100	K-X-282W/41	21,252	96.6	1/0	125
XB2827-D-380-3PY	K-X-2827/52	380/3PY	17,388	26.3	8 ga	40	K-X-282W/52	21,252	43.9	6 ga	60
XB2827-D-400-3PY	K-X-2827/82	400/3PY	17,388	25.2	8 ga	40	K-X-282W/82	21,252	42.0	6 ga	60
XB2827-D-415-3PY	K-X-2827/72	415/3PY	17,388	24.2	8 ga	40	K-X-282W/72	21,252	40.2	6 ga	60
X2836-D-220	K-X-2836/41	220/1P	19,907	90.5	1/0	125	K-X-283P/41	23,226	105.6	3/0	150
X2836-D-380-3PY	K-X-2836/52	380/3PY	19,907	45.2	6 ga	60	K-X-283P/52	23,226	45.3	6 ga	60
X2836-D-400-3PY	K-X-2836/82	400/3PY	19,907	43.3	6 ga	60	K-X-283P/82	23,226	43.3	6 ga	60
X2836-D-415-3PY	K-X-2836/72	415/3PY	19,907	41.5	6 ga	60	K-X-283P/72	23,226	41.5	6 ga	60
XB2836-D-220	K-X-2836/41	220/1P	23,184	105.4	3/0	150	K-X-283W/41	27,050	123.0	4/0	175
XB2836-D-380-3PY	K-X-2836/52	380/3PY	23,184	52.7	4 ga	70	K-X-283W/52	27,050	52.7	4 ga	70
XB2836-D-400-3PY	K-X-2836/82	400/3PY	23,184	50.4	4 ga	70	K-X-283W/82	27,050	50.4	4 ga	70
XB2836-D-415-3PY	K-X-2836/72	415/3PY	23,184	48.3	4 ga	70	K-X-283W/72	27,050	48.3	4 ga	70
X2845-D-220	K-X-2845/41	220/1P	24,885	113.1	3/0	150	K-X-284P/41	28,203	128.2	4/0	175
X2845-D-380-3PY	K-X-2845/52	380/3PY	24,885	45.2	6 ga	60	K-X-284P/52	28,203	45.3	6 ga	60
X2845-D-400-3PY	K-X-2845/82	400/3PY	24,885	43.3	6 ga	60	K-X-284P/82	28,203	43.3	6 ga	60
X2845-D-415-3PY	K-X-2845/72	415/3PY	24,885	41.5	6 ga	60	K-X-284P/72	28,203	41.5	6 ga	60
XB2845-D-220	K-X-2845/41	220/1P	28,980	131.7	4/0	175	K-X-284W/41	32,845	149.3	250 mcm	200
XB2845-D-380-3PY	K-X-2845/52	380/3PY	28,980	52.7	4 ga	70	K-X-284W/52	32,845	52.7	4 ga	70
XB2845-D-400-3PY	K-X-2845/82	400/3PY	28,980	50.4	4 ga	70	K-X-284W/82	32,845	50.4	4 ga	70
XB2845-D-415-3PY	K-X-2845/72	415/3PY	28,980	48.3	4 ga	70	K-X-284W/72	32,845	48.3	4 ga	70

ELECTRICAL NOTES FOR X2800 SERIES

For Model Number Powered Bottom Model: Add a "PB" after the "D" (Example = X2827-D-PB-240-1).

UL Listing: All models are c-MET-us listed.

Control Panels: All X2800 kilns get a floor standing panel. NEMA 1 panel are recommended but not required for 480 volts.

XB MODELS: XB models have more power than the regular X model kilns. The higher powered XB elements are always used on the XB2818 because of the large ratio of unheated surface area.

480 Volt Models with Quad Element Option: See website kiln pages for electrical specifications.

Dimension & Weight Specifications for X2800 Series

Model Number	Inside Height	Cubic Feet	Furniture Kit	Furniture Kit Part No.	Outside Dimensions	Shipping Dimensions (with Kit)	Ship Weight Kiln Only	Ship Weight Kiln + Kit
XB2818-D	18"	7.3	4 shelves, 1 post kit	H-X-K818/00	59" W x 74" H x 46" D	1 crate: 48" W x 46" H x 48" D 1 crate: 45" W x 84" H x 48" D	800 lbs	915 lbs
X2827-D	27"	11.0	6 shelves, 1 post kit	H-X-K827/00	59" W x 84" H x 46" D	1 crate: 48" W x 72" H x 48" D 1 crate: 45" W x 93" H x 48" D	825 lbs	930 lbs
X2836-D	36"	14.6	8 shelves, 2 post kits	H-X-K836/00	59" W x 93" H x 46" D	1 crate: 48" W x 82" H x 48" D 1 crate: 45" W x 93" H x 48" D	910 lbs	1045 lbs
X2845-D	45"	18.3	10 shelves, 2 post kits	H-X-K845/00	59" W x 102" H x 46" D	1 crate: 48" W x 54" H x 48" D 1 crate: 48" W x 93" H x 48" D 1 crate: 45" W x 42" H x 48" D	1045 lbs	1205 lbs
METRIC DIMENSIONS (CM, LITERS & KG)								
XB2818-D	45.7	208 L	4 shelves, 1 post kit	H-X-K818/00	150 W x 188 H x 117 D	1 crate: 122 W x 117 H x 122 D 1 crate: 115 W x 214 H x 122 D	363 KG	416 KG
X2827-D	68.6	311 L	6 shelves, 1 post kit	H-X-K827/00	150 W x 213 H x 117 D	1 crate: 122 W x 183 H x 122 D 1 crate: 115 W x 237 H x 122 D	375 KG	422 KG
X2836-D	91.4	415 L	8 shelves, 2 post kits	H-X-K836/00	150 W x 236 H x 117 D	1 crate: 122 W x 209 H x 122 D 1 crate: 115 W x 237 H x 122 D	413 KG	475 KG
X2845-D	114.3	357 L	10 shelves, 2 post kits	H-X-K845/00	150 W x 259 H x 117 D	1 crate: 122 W x 138 H x 122 D 1 crate: 122 W x 237 H x 122 D 1 crate: 122 W x 213 H x 107 D	475 KG	547 KG

DIMENSION & SHIPPING NOTES

Cross section of Inside: Approximately 27" wide by 27" deep. (68.6 cm by 68.6 cm)

Hearth Setting Area: 23" wide by 23" deep. (58.4 cm by 58.4 cm)

Recommended Minimum Space Requirements: 89.7" wide by 75.6" deep (227.8 cm by 192 cm)
(See General Dimension Diagram for details).

MORE: See each model page on hotkilns.com to download PDF General Dimension Drawings for more outside and inside dimensions, minimum space requirements, BTU ventilation requirements, and kiln weight. See the Shipping Tab on the model page for complete shipping dimension and shipping weight information.

XB2818

Temperature Rating: Cone 10

Volume: 7.3 Cubic Feet

Brick Thickness: 3" Brick

Inside: 26.5" D x 18" H

Outside Dimensions: 59" W x 74" H x 46" D

Shipping Dim with Vent & Furn Kit: 2 Crate (48" W x 46" H x 48" D & 48" W x 74" H x 48" D)

Ship Weight (Kiln): 800 LBS

Ship Weight (Kiln, Vent & Furn Kit): 915 LBS

FURNITURE KIT FOR XB2818

Part Number: H-X-K818/00

Includes: Four 23" X 11-1/2" Rectangular Shelves (3/4" thick), Six Each 1/2", 1", 2", 4", 6", and 8" Square Posts, Heat Resistant Gloves.



X2827

Temperature Rating: Cone 10

Volume: 11.0 Cubic Feet

Brick Thickness: 3" Brick

Inside: 26.5" D x 27" H

Outside Dimensions: 59" W x 84" H x 46" D

Shipping Dim with Vent & Furn Kit: 2 Crate (48" W x 82" H x 48" D & 48" W x 84" H x 48" D)

Ship Weight (Kiln): 825 LBS

Ship Weight (Kiln, Vent & Furn Kit): 930 LBS

FURNITURE KIT FOR X2827

Part Number: H-X-K827/00

Includes: Six 23" X 11-1/2" Rectangular Shelves (3/4" thick), Six Each 1/2", 1", 2", 4", 6", and 8" Square Posts, Heat Resistant Gloves.



X2836

Temperature Rating: Cone 10

Volume: 14.6 Cubic Feet

Brick Thickness: 3" Brick

Inside: 26.5" D x 36" H

Outside Dimensions: 59" W x 93" H x 46" D

Shipping Dim with Vent & Furn Kit: 2 Crate (48" W x 82" H x 48" D & 48" W x 84" H x 48" D)

Ship Weight (Kiln): 910 LBS

Ship Weight (Kiln, Vent & Furn Kit): 1,045 LBS

FURNITURE KIT FOR X2836

Part Number: H-X-K836/00

Includes: Eight 23" X 11-1/2" Rectangular Shelves (3/4" thick), Twelve Each 1/2", 1", 2", 4", 6", and 8" Square Posts, Heat Resistant Gloves.



X2845

Temperature Rating: Cone 10

Volume: 18.3 Cubic Feet

Brick Thickness: 3" Brick

Inside: 26.5" D x 45" H

Outside Dimensions: 59" W x 102" H x 46" D

Shipping Dim with Vent & Furn Kit: 3 Crate (48" W x 54" H x 48" D, 48" W x 36" H x 48" D, & 48" W x 84" H x 48" D)

Ship Weight (Kiln): 1,045 LBS

Ship Weight (Kiln, Vent & Furn Kit): 1,205 LBS

FURNITURE KIT FOR X2845

Part Number: H-X-K845/00

Includes: Ten 23" X 11-1/2" Rectangular Shelves (3/4" thick), Twelve Each 1/2", 1", 2", 4", 6", and 8" Square Posts, and One Pair Heat Resistant Gloves.



Electrical Specifications for X3200 Series (USA)

Standard Models							Powered Bottom Models				
Model Number	Part Number	Volt/Phase	Watts	Amps	Wire Size	Fuse Size	Part Number	Watts	Amps	Wire Size	Fuse Size
XB3218-D-240	K-X-3218/31	240/1P	14,196	59.2	3 ga	80	K-X-321P/31	18,928	78.9	1 ga	100
XB3218-D-240-3P	K-X-3218/32	240/3P	14,196	51.2	4 ga	70	K-X-321P/32	18,928	51.2	4 ga	70
XB3218-D-208	K-X-3218/21	208/1P	14,196	68.3	2 ga	90	K-X-321P/21	18,928	91.0	1/0	125
XB3218-D-208-3P	K-X-3218/22	208/3P	14,196	59.1	3 ga	80	K-X-321P/22	18,928	59.1	3 ga	80
XB3218-D-480-3P	K-X-3218/62	480/3P	14,196	17.1	12 ga	25	K-X-321P/62	18,928	25.6	8 ga	40
X3227-D-240	K-X-3227/31	240/1P	18,039	75.2	1 ga	100	K-X-322P/31	22,047	91.9	1/0	125
X3227-D-240-3P	K-X-3227/32	240/3P	18,039	43.4	6 ga	60	K-X-322P/32	22,047	58.5	3 ga	80
X3227-D-208	K-X-3227/21	208/1P	18,039	86.7	1 ga	110	K-X-322P/21	22,047	106.0	3/0	150
X3227-D-208-3P	K-X-3227/22	208/3P	18,039	50.1	4 ga	70	K-X-322P/22	22,047	67.4	2 ga	90
X3227-D-480-3P	K-X-3227/62	480/3P	18,039	21.7	10 ga	30	K-X-322P/62	22,047	28.9	8 ga	40
XB3227-D-240	K-X-322B/31	240/1P	21,294	88.7	1/0	125	K-X-322W/31	26,026	108.4	3/0	150
XB3227-D-240-3P	K-X-322B/32	240/3P	21,294	51.2	4 ga	70	K-X-322W/32	26,026	69.0	2 ga	90
XB3227-D-208	K-X-322B/21	208/1P	21,294	102.4	3/0	150	K-X-322W/21	26,026	125.1	4/0	175
XB3227-D-208-3P	K-X-322B/22	208/3P	21,294	59.1	3 ga	80	K-X-322W/22	26,026	79.6	1 ga	100
XB3227-D-480-3P	K-X-322B/62	480/3P	21,294	25.6	8 ga	40	K-X-322W/62	26,026	34.2	6 ga	50
X3236-D-240	K-X-3236/31	240/1P	24,052	100.2	3/0	150	K-X-323P/31	28,060	116.9	3/0	150
X3236-D-240-3P	K-X-3236/32	240/3P	24,052	66.3	2 ga	90	K-X-323P/32	28,060	79.7	1 ga	100
X3236-D-208	K-X-3236/21	208/1P	24,052	115.6	3/0	150	K-X-323P/21	28,060	134.9	4/0	175
X3236-D-208-3P	K-X-3236/22	208/3P	24,052	76.5	1 ga	100	K-X-323P/22	28,060	91.9	1/0	125
X3236-D-480-3P	K-X-3236/62	480/3P	24,052	28.9	8 ga	40	K-X-323P/62	28,060	36.2	6 ga	50
XB3236-D-240	K-X-323B/31	240/1P	28,392	118.3	3/0	150	K-X-323W/31	33,124	138.0	4/0	175
XB3236-D-240-3P	K-X-323B/32	240/3P	28,392	78.2	1 ga	100	K-X-323W/32	33,124	94.0	1/0	125
XB3236-D-208	K-X-323B/21	208/1P	28,392	136.5	4/0	175	K-X-323W/21	33,124	159.3	250 mcm	200
XB3236-D-208-3P	K-X-323B/22	208/3P	28,392	90.3	1/0	125	K-X-323W/22	33,124	108.5	3/0	150
XB3236-D-480-3P	K-X-323B/62	480/3P	28,392	43.2	6 ga	50	K-X-323W/62	33,124	42.7	6 ga	60
X3245-D-240	K-X-3245/31	240/1P	30,065	125.3	4/0	175	K-X-324P/31	34,074	142.0	250 mcm	200
X3245-D-240-3P	K-X-3245/32	240/3P	30,065	86.8	1 ga	110	K-X-324P/32	34,074	86.8	1 ga	110
X3245-D-208	K-X-3245/21	208/1P	30,065	144.5	250 mcm	200	K-X-324P/21	34,074	163.8	300 mcm	225
X3245-D-208-3P	K-X-3245/22	208/3P	30,065	100.1	3/0	150	K-X-324P/22	34,074	100.2	3/0	150
X3245-D-480-3P	K-X-3245/62	480/3P	30,065	36.2	6 ga	50	K-X-324P/62	34,074	43.4	6 ga	60
XB3245-D-240	K-X-324B/31	240/1P	35,490	147.9	250 mcm	200	K-X-324W/31	40,222	167.6	300 mcm	225
XB3245-D-240-3P	K-X-324B/32	240/3P	35,490	102.5	3/0	150	K-X-324W/32	40,222	102.5	3/0	150
XB3245-D-208	K-X-324B/21	208/1P	35,490	170.6	300 mcm	225	K-X-324W/21	40,222	193.4	350 mcm	250
XB3245-D-208-3P	K-X-324B/22	208/3P	35,490	118.2	3/0	150	K-X-324W/22	40,222	118.2	3/0	150
XB3245-D-480-3P	K-X-324B/62	480/3P	35,490	42.7	6 ga	60	K-X-324W/62	40,222	51.3	4 ga	70

SEE PAGE 27 FOR ELECTRICAL NOTES

Electrical Specifications for X3200 Series (World)

Standard Models							Powered Bottom Models				
Model Number	Part Number	Volt/Phase	Watts	Amps	Wire Size	Fuse Size	Part Number	Watts	Amps	Wire Size	Fuse Size
XB3218-D-220	K-X-3218/41	220/1P	14,196	64.5	2 ga	90	K-X-321P/41	18,928	86.0	1 ga	110
XB3218-D-380-3PY	K-X-3218/52	380/3PY	14,196	32.3	6 ga	50	K-X-321P/52	18,928	32.3	6 ga	50
XB3218-D-400-3PY	K-X-3218/82	400/3PY	14,196	30.9	8 ga	40	K-X-321P/82	18,928	30.9	8 ga	40
XB3218-D-415-3P4	K-X-3218/72	415/3PY	14,196	29.6	8 ga	40	K-X-321P/72	18,928	29.6	8 ga	40
X3227-D-220	K-X-3227/41	220/1P	18,039	82.0	1 ga	110	K-X-322P/41	22,047	100.2	3/0	150
X3227-D-380-3PY	K-X-3227/52	380/3PY	18,039	27.3	8 ga	40	K-X-322P/52	22,047	45.5	6 ga	60
X3227-D-400-3PY	K-X-3227/82	400/3PY	18,039	26.1	8 ga	40	K-X-322P/82	22,047	43.6	6 ga	60
X3227-D-415-3PY	K-X-3227/72	415/3PY	18,039	25.1	8 ga	40	K-X-322P/72	22,047	41.7	6 ga	60
XB3227-D-220	K-X-3227/41	220/1P	21,294	96.8	1/0	125	K-X-322W/41	26,026	118.3	3/0	150
XB3227-D-380-3PY	K-X-3227/52	380/3PY	21,294	32.3	6 ga	50	K-X-322W/52	26,026	53.8	4 ga	70
XB3227-D-400-3PY	K-X-3227/82	400/3PY	21,294	30.9	8 ga	40	K-X-322W/82	26,026	51.4	4 ga	70
XB3227-D-415-3PY	K-X-3227/72	415/3PY	21,294	29.6	8 ga	40	K-X-322W/72	26,026	49.3	4 ga	70
X3236-D-220	K-X-3236/41	220/1P	24,052	109.3	3/0	150	K-X-323P/41	28,060	127.5	4/0	175
X3236-D-380-3PY	K-X-3236/52	380/3PY	24,052	54.7	4 ga	70	K-X-323P/52	28,060	54.7	4 ga	70
X3236-D-400-3PY	K-X-3236/82	400/3PY	24,052	52.3	4 ga	70	K-X-323P/82	28,060	52.3	4 ga	70
X3236-D-415-3PY	K-X-3236/72	415/3PY	24,052	50.1	4 ga	70	K-X-323P/72	28,060	50.1	4 ga	70
XB3236-D-220	K-X-3236/41	220/1P	28,392	129.1	4/0	175	K-X-323W/41	31,124	150.6	250 mcm	200
XB3236-D-380-3PY	K-X-3236/52	380/3PY	28,392	64.5	2 ga	90	K-X-323W/52	31,124	64.5	2 ga	90
XB3236-D-400-3PY	K-X-3236/82	400/3PY	28,392	61.7	3 ga	80	K-X-323W/82	31,124	61.7	3 ga	80
XB3236-D-415-3PY	K-X-3236/72	415/3PY	28,392	59.2	3 ga	80	K-X-323W/72	31,124	59.2	3 ga	80
X3245-D-220	K-X-3245/41	220/1P	30,065	136.7	4/0	175	K-X324P/41	34,074	154.9	250 mcm	200
X3245-D-380-3PY	K-X-3245/52	380/3PY	30,065	54.7	4 ga	70	K-X324P/52	34,074	54.7	4 ga	70
X3245-D-400-3PY	K-X3245/82	400/3PY	30,065	52.3	4 ga	70	K-X324P/82	34,074	52.3	4 ga	70
X3245-D-415-3PY	K-X3245/72	415/3PY	30,065	50.1	4 ga	70	K-X324P/72	34,074	50.1	4 ga	70
XB3245-D-220	K-X3245/41	220/1P	35,490	161.3	300 mcm	225	K-X324W/41	40,222	182.8	350 mcm	250
XB3245-D-380-3PY	K-X3245/52	380/3PY	35,490	64.5	2 ga	90	K-X324W/52	40,222	64.5	2 ga	90
XB3245-D-400-3PY	K-X3245/82	400/3PY	35,490	61.7	3 ga	80	K-X324W/82	40,222	61.7	2 ga	80
XB3245-D-415-3PY	K-X3245/72	415/3PY	35,490	59.2	3 ga	80	K-X324W/72	40,222	59.2	3 ga	80

ELECTRICAL NOTES FOR X3200 SERIES

For Model Number of Powered Bottom Model: Add a "PB" after the "D" (Example = X3227-D-PB-240-1).

UL Listing: All models are c-MET-us listed.

Control Panels: All X3200 kilns get a floor standing panel. NEMA 1 panel are recommended but not required for 480 volts.

XB MODELS: XB models have more power than the regular X model kilns. The higher powered XB elements are always used on the XB3218 because of the large ratio of unheated surface area.

480 Volt Models with Quad Element Option: See website kiln pages for electrical specifications.

Dimension & Weight Specifications for X3200 Series

Model Number	Inside Height	Cubic Feet	Furniture Kit	Furniture Kit Part No.	Outside Dimensions	Shipping Dimensions (with Kit)	Ship Weight Kiln Only	Ship Weight Kiln + Kit
XB3218-D	18"	9.7	4 shelves, 1 post kit	H-X-K218/00	63" W x 74" H x 51" D	1 crate: 48" W x 60" H x 50" D 1 crate: 45" W x 84" H x 48" D	800 lbs	915 lbs
X3227-D	27"	14.5	6 shelves, 1 post kit	H-X-K227/00	63" W x 84" H x 51" D	1 crate: 48" W x 72" H x 50" D 1 crate: 45" W x 93" H x 50" D	1,020 lbs	1,170 lbs
X3236-D	36"	19.4	8 shelves, 2 post kits	H-X-K236/00	63" W x 93" H x 51" D	1 crate: 48" W x 84" H x 50" D 1 crate: 45" W x 93" H x 48" D	1,120 lbs	1,310 lbs
X3245-D	45"	24.2	10 shelves, 2 post kits	H-X-K245/00	63" W x 102" H x 51" D	1 crate: 48" W x 54" H x 50" D 1 crate: 45" W x 93" H x 48" D 1 crate: 48" W x 42" H x 50" D	1,265 lbs	1,495 lbs
METRIC DIMENSIONS (CM, LITERS & KG)								
XB3218-D	45.7	275 L	4 shelves, 1 post kit	H-X-K218/00	160 W x 188 H x 130 D	1 crate: 122 W x 188 H x 153 D 1 crate: 115 W x 188 H x 214 D	363 KG	416 KG
X3227-D	68.6	412 L	6 shelves, 1 post kit	H-X-K227/00	160 W x 213 H x 130 D	1 crate: 122 W x 183 H x 127 D 1 crate: 115 W x 237 H x 127 D	463 KG	531 KG
X3236-D	91.4	549 L	8 shelves, 2 post kits	H-X-K236/00	160 W x 236 H x 130 D	1 crate: 122 W x 214 H x 127 D 1 crate: 115 W x 237 H x 127 D	509 KG	595 KG
X3245-D	114.3	686 L	10 shelves, 2 post kits	H-X-K245/00	160 W x 259 H x 130 D	1 crate: 122 W x 138 H x 127 D 1 crate: 115 W x 237 H x 127 D 1 crate: 122 W x 107 H x 127 D	574 KG	679 KG

DIMENSION & SHIPPING NOTES

Cross section of Inside: Approximately 32" wide by 32" deep. (81.3 cm by 81.3 cm)

Hearth Setting Area: 28" wide by 28" deep. (71.1 cm by 71.2 cm)

Recommended Minimum Space Requirements: 94.4" wide by 80.3" deep (239.7 cm by 204 cm)
(See General Dimension Diagram for details).

MORE: See each model page on hotkilns.com to download PDF General Dimension Drawings for more outside and inside dimensions, minimum space requirements, BTU ventilation requirements, and kiln weight. See the Shipping Tab on the model page for complete shipping dimension and shipping weight information.

XB3218

Temperature Rating: Cone 10

Volume: 9.7 Cubic Feet

Brick Thickness: 3" Brick

Inside: 30.5" D x 18" H

Outside Dimensions: 63" W x 74" H x 51" D

Shipping Dim with Vent & Furn Kit: 2 Crate (48" W x 60" H x 50" D & 48" W x 60" H x 50" D)

Ship Weight (Kiln): 800 LBS

Ship Weight (Kiln, Vent & Furn Kit): 915 LBS

FURNITURE KIT FOR XB3218

Part Number: H-X-K218/00

Includes: Four 28" X 14" Rectangular Shelves (3/4" thick), Six Each 1/2", 1", 2", 4", 6", and 8" Square Posts, and One Pair Heat Resistant Gloves.



X3227

Temperature Rating: Cone 10

Volume: 14.5 Cubic Feet

Brick Thickness: 3" Brick

Inside: 30.5" D x 27" H

Outside Dimensions: 63" W x 84" H x 51" D

Shipping Dim with Vent & Furn Kit: 2 Crate (48" W x 72" H x 50" D & 48" W x 60" H x 50" D)

Ship Weight (Kiln): 1,020 LBS

Ship Weight (Kiln, Vent & Furn Kit): 1,170 LBS

FURNITURE KIT FOR X3227

Part Number: H-X-K227/00

Includes: Six 28" X 14" Rectangular Shelves (3/4" thick), Six Each 1/2", 1", 2", 4", 6", and 8" Square Posts, and One Pair Heat Resistant Gloves.



X3236

Temperature Rating: Cone 10

Volume: 19.4 Cubic Feet

Brick Thickness: 3" Brick

Inside: 30.5" D x 36" H

Outside Dimensions: 63" W x 93" H x 51" D

Shipping Dim with Vent & Furn Kit: 2 Crate (48" W x 84" H x 50" D & 48" W x 60" H x 50" D)

Ship Weight (Kiln): 970 LBS

Ship Weight (Kiln, Vent & Furn Kit): 1,120 LBS

FURNITURE KIT FOR X3236

Part Number: H-X-K236/00

Includes: Eight 28" X 14" Rectangular Shelves (3/4" thick), Twelve Each 1/2", 1", 2", 4", 6", and 8" Square Posts, and One Pair Heat Resistant Gloves.



X3245

Temperature Rating: Cone 10

Volume: 24.2 Cubic Feet

Brick Thickness: 3" Brick

Inside: 30.5" D x 45" H

Outside Dimensions: 63" W x 102" H x 51" D

Shipping Dim with Vent & Furn Kit: 3 Crate (48" W x 54" H x 50" D, 48" W x 60" H x 50" D, & 48" W x 60" H x 50" D)

Ship Weight (Kiln): 1,265 LBS

Ship Weight (Kiln, Vent & Furn Kit): 1,495 LBS

FURNITURE KIT FOR X3245

Part Number: H-X-K245/00

Includes: Ten 28" X 14" Rectangular Shelves (3/4" thick), Twelve Each 1/2", 1", 2", 4", 6", and 8" Square Posts, and One Pair Heat Resistant Gloves.



Electrical Specifications for T2300 Series (USA)

Standard Models							Powered Bottom Models				
Model Number	Part Number	Volt/Phase	Watts	Amps	Wire Size	Fuse Size	Part Number	Watts	Amps	Wire Size	Fuse Size
TB2318-D-240	K-T-2318/31	240/1P	15,340	63.9	3 ga	80	K-T-231P/31	20,453	85.2	1 ga	110
TB2318-D-240-3P	K-T-2318/32	240/3P	15,340	55.4	4 ga	70	K-T-231P/32	20,453	55.4	4 ga	70
TB2318-D-208	K-T-2318/21	208/1P	15,340	73.8	1 ga	100	K-T-231P/21	20,453	98.3	1/0	125
TB2318-D-208-3P	K-T-2318/22	208/3P	15,340	63.9	3 ga	80	K-T-231P/22	20,453	63.9	3 ga	80
TB2318-D-480-3P	K-T-2318/62	480/3P	15,340	18.5	12 ga	25	K-T-231P/62	20,453	27.7	8 ga	40
T2327-D-240	K-T-2327/31	240/1P	19,510	81.3	1 ga	110	K-T-232P/31	23,844	99.4	1/0	125
T2327-D-240-3P	K-T-2327/32	240/3P	19,510	46.9	6 ga	60	K-T-232P/32	23,844	63.2	3 ga	80
T2327-D-208	K-T-2327/21	208/1P	19,510	93.8	1/0	125	K-T-232P/21	23,844	114.6	3/0	150
T2327-D-208-3P	K-T-2327/22	208/3P	19,510	54.2	4 ga	70	K-T-232P/22	23,844	72.9	1 ga	100
T2327-D-480-3P	K-T-2327/62	480/3P	19,510	23.5	10 ga	30	K-T-232P/62	23,844	31.3	8 ga	40
TB2327-D-240	K-T-232B/31	240/1P	23,010	95.9	1/0	125	K-T-232W/31	28,123	117.2	3/0	150
TB2327-D-240-3P	K-T-232B/32	240/3P	23,010	55.4	4 ga	70	K-T-232W/32	28,123	74.6	1 ga	100
TB2327-D-208	K-T-232B/21	208/1P	23,010	110.6	3/0	150	K-T-232W/21	28,123	135.2	4/0	175
TB2327-D-208-3P	K-T-232B/22	208/3P	23,010	63.9	3 ga	80	K-T-232W/22	28,123	86.0	1 ga	110
TB2327-D-480-3P	K-T-232B/62	480/3P	23,010	27.7	8 ga	40	K-T-232W/62	28,123	36.9	6 ga	50
T2336-D-240	K-T-2336/31	240/1P	26,013	108.4	3/0	150	K-T-233P/31	30,347	126.4	4/0	175
T2336-D-240-3P	K-T-2336/32	240/1P	26,013	71.7	2 ga	90	K-T-233P/32	30,347	86.2	1 ga	110
T2336-D-208	K-T-2336/21	208/1P	26,013	125.1	4/0	175	K-T-233P/21	30,347	145.9	250 mcm	200
T2336-D-208-3P	K-T-2336/22	208/3P	26,013	82.7	1 ga	110	K-T-233P/22	30,347	99.4	1/0	125
T2336-D-480-3P	K-T-2336/62	480/3P	26,013	31.3	8 ga	40	K-T-233P/62	30,347	39.1	6 ga	50
TB2336-D-240	K-T-233B/31	240/1P	30,680	127.8	4/0	175	K-T-233W/31	35,793	149.1	250 mcm	200
TB2336-D-240-3P	K-T-233B/32	240/1P	30,680	84.6	1 ga	110	K-T-233W/32	35,793	101.6	3/0	150
TB2336-D-208	K-T-233B/21	208/1P	30,680	147.5	250 mcm	200	K-T-233W/21	35,793	172.1	300 mcm	225
TB2336-D-208-3P	K-T-233B/22	208/3P	30,680	97.6	1/0	125	K-T-233W/22	35,793	117.3	3/0	150
TB2336-D-480-3P	K-T-233B/62	480/3P	30,680	36.9	6 ga	50	K-T-233W/62	35,793	46.2	6 ga	60
T2345-D-240	K-T-2345/31	240/1P	32,515	135.5	4/0	175	K-T-234P/31	36,850	153.5	250 mcm	200
T2345-D-240-3P	K-T-2345/32	240/3P	32,515	93.9	1/0	125	K-T-234P/32	36,850	93.9	1/0	125
T2345-D-208	K-T-2345/21	208/1P	32,515	156.3	250 mcm	200	K-T-234P/21	36,850	177.2	300 mcm	225
T2345-D-208-3P	K-T-2345/22	208/3P	32,515	108.3	3/0	150	K-T-234P/22	36,850	62.5	3 ga	80
T2345-D-480-3P	K-T-2345/62	480/3P	32,515	39.1	6 ga	50	K-T-234P/62	36,850	47.0	6 ga	60
TB2345-D-240	K-T-234B/31	240/1P	38,350	159.8	250 mcm	200	K-T-234W/31	43,463	181.1	350 mcm	250
TB2345-D-240-3P	K-T-234B/32	240/3P	38,350	110.7	3/0	150	K-T-234W/32	43,463	110.7	3/0	150
TB2345-D-208	K-T-234B/21	208/1P	38,350	184.4	350 mcm	250	K-T-234W/21	43,463	209.0	400 mcm	275
TB2345-D-208-3P	K-T-234B/22	208/3P	38,350	127.7	4/0	175	K-T-234W/22	43,463	127.8	4/0	175
TB2345-D-480-3P	K-T-234B/62	480/3P	38,350	46.1	6 ga	60	K-T-234W/62	43,463	55.4	4 ga	70

SEE PAGE 34 FOR ELECTRICAL NOTES

Electrical Specifications for T2300 Series (World)

Standard Models							Powered Bottom Models				
Model Number	Part Number	Volt/Phase	Watts	Amps	Wire Size	Fuse Size	Part Number	Watts	Amps	Wire Size	Fuse Size
TB2318-D-220	K-T-2318/41	220/1P	15,340	69.7	2 ga	90	K-T-231W/41	20,453	93.0	1/0	125
TB2318-D-380-3PY	K-T-2318/52	380/3PY	15,340	34.9	6 ga	50	K-T-231W/52	20,453	34.9	6 ga	50
TB2318-D-400-3PY	K-T-2318/82	400/3PY	15,340	33.3	6 ga	50	K-T-231W/82	20,453	33.4	6 ga	50
TB2318-D-415-3P4	K-T-2318/72	415/3PY	15,340	32.0	8 ga	40	K-T-231W/72	20,453	32.0	8 ga	40
T2327-D-220	K-T-2327/41	220/1P	19,510	88.7	1/0	125	K-T-232P/41	23,844	108.4	3/0	150
T2327-D-380-3PY	K-T-2327/52	380/3PY	19,510	29.6	8 ga	40	K-T-232P/52	23,844	49.3	4 ga	70
T2327-D-400-3PY	K-T-2327/82	400/3PY	19,510	28.3	8 ga	40	K-T-232P/82	23,844	47.1	6 ga	60
T2327-D-415-3PY	K-T-2327/72	415/3PY	19,510	27.1	8 ga	40	K-T-232P/72	23,844	45.1	6 ga	60
TB2327-D-220	K-T-232B/41	220/1P	23,010	104.6	3/0	150	K-T-232W/41	28,123	127.8	4/0	175
TB2327-D-380-3PY	K-T-232B/52	380/3PY	23,010	34.9	6 ga	50	K-T-232W/52	28,123	58.1	3 ga	80
TB2327-D-400-3PY	K-T-232B/82	400/3PY	23,010	33.3	6 ga	50	K-T-232W/82	28,123	55.6	4 ga	70
TB2327-D-415-3PY	K-T-232B/72	415/3PY	23,010	32.0	8 ga	40	K-T-232W/72	28,123	53.3	4 ga	70
T2336-D-220	K-T-2336/41	220/1P	26,013	118.2	3/0	150	K-T-233P/41	30,347	137.9	4/0	175
T2336-D-380-3PY	K-T-2336/52	380/3PY	26,013	59.1	3 ga	80	K-T-233P/52	30,347	59.1	3 ga	80
T2336-D-400-3PY	K-T-2336/82	400/3PY	26,013	56.6	3 ga	80	K-T-233P/52	30,347	56.6	3 ga	80
T2336-D-415-3PY	K-T-2336/72	415/3PY	26,013	54.2	4 ga	70	K-T-233P/72	30,347	54.2	4 ga	70
TB2336-D-220	K-T-233B/41	220/1P	30,680	139.5	4/0	175	K-T-233W/41	35,793	162.7	300 mcm	225
TB2336-D-380-3PY	K-T-233B/52	380/3PY	30,680	69.7	2 ga	90	K-T-233W/52	35,793	69.7	2 ga	90
TB2336-D-400-3PY	K-T-233B/82	400/3PY	30,680	66.7	2 ga	90	K-T-233W/82	35,793	66.7	2 ga	90
TB2336-D-415-3PY	K-T-233B/72	415/3PY	30,680	63.9	3 ga	80	K-T-233W/72	35,793	63.9	3 ga	80
T2345-D-220	K-T-2345/41	220/1P	32,515	147.8	250 mcm	200	K-T-234P/41	36,850	167.5	300 mcm	225
T2345-D-380-3PY	K-T-2345/52	380/3PY	32,515	34.2	6 ga	50	K-T-234P/52	36,850	59.1	3 ga	80
T2345-D-400-3PY	K-T-2345/82	400/3PY	32,515	32.5	6 ga	50	K-T-234P/82	36,850	56.6	3 ga	80
T2345-D-415-3PY	K-T-2345/72	415/3PY	32,515	31.3	8 ga	40	K-T-234P/72	36,850	54.2	4 ga	70
TB2345-D-220	K-T-234B/41	220/1P	38,350	174.3	300 mcm	225	K-T-234W/41	43,463	197.6	350 mcm	250
TB2345-D-380-3PY	K-T-234B/52	380/3PY	38,350	69.7	2 ga	90	K-T-234W/52	43,463	69.7	2 ga	90
TB2345-D-400-3PY	K-T-234B/82	400/3PY	38,350	66.7	2 ga	90	K-T-234W/82	43,463	66.7	2 ga	90
TB2345-D-415-3PY	K-T-234B/72	415/3PY	38,350	63.9	3 ga	80	K-T-234W/72	43,463	63.9	3 ga	80

ELECTRICAL NOTES FOR T2300 SERIES

For Model Number of Powered Bottom Model: Add a “PB” after the “D” (Example = T2327-D-PB-240-1).

UL Listing: All models are c-MET-us listed.

Control Panels: All T2300 kilns get a floor standing panel. NEMA 1 panel are recommended but not required for 480 volts.

TB MODELS: TB models have more power than the regular T model kilns. The higher powered TB elements are always used on the TB2318 because of the large ratio of unheated surface area.

480 Volt Models with Quad Element Option: See website kiln pages for electrical specifications.

Dimension & Weight Specifications for T2300 Series

Model Number	Inside Height	Cubic Feet	Furniture Kit	Furniture Kit Part No.	Outside Dimensions	Shipping Dimensions (with Kit)	Ship Weight Kiln Only	Ship Weight Kiln + Kit
TB2318-D	18"	9.6	4 shelves, 1 post kit	H-T-K418/00	68" W x 72" H x 47" D	1 crate: 49" W x 46" H x 59" D 1 crate: 45" W x 84" H x 48" D	905 lbs	1,005 lbs
T2327-D	27"	14.4	6 shelves, 1 post kit	H-T-K427/00	68" W x 84" H x 47" D	1 crate: 49" W x 72" H x 59" D 1 crate: 45" W x 93" H x 48" D	1,035 lbs	1,170 lbs
T2336-D	36"	19.2	8 shelves, 2 post kits	H-T-K436/00	68" W x 93" H x 47" D	1 crate: 49" W x 82" H x 59" D 1 crate: 45" W x 93" H x 48" D	1,135 lbs	1,315 lbs
T2345-D	45"	24.0	10 shelves, 2 post kits	H-T-K445/00	68" W x 102" H x 47" D	1 crate: 49" W x 72" H x 59" D 1 crate: 45" W x 93" H x 48" D 1 crate: 49" W x 48" H x 59" D	1,285 lbs	1,500 lbs
METRIC DIMENSIONS (CM, LITERS & KG)								
TB2318-D	45.7	272 L	4 shelves, 1 post kit	H-T-K418/00	173 W x 183 H x 119 D	1 crate: 125 W x 117 H x 150 D 1 crate: 115 W x 214 H x 122 D	411 KG	456 KG
T2327-D	68.6	408 L	6 shelves, 1 post kit	H-T-K427/00	173 W x 213 H x 119 D	1 crate: 125 W x 183 H x 150 D 1 crate: 115 W x 237 H x 122 D	470 KG	531 KG
T2336-D	91.4	544 L	8 shelves, 2 post kits	H-T-K436/00	173 W x 236 H x 119 D	1 crate: 125 W x 209 H x 150 D 1 crate: 115 W x 237 H x 122 D	515 KG	597 KG
T2345-D	114.2	24.0 L	10 shelves, 2 post kits	H-T-K445/00	173 W x 259 H x 119 D	1 crate: 125 W x 183 H x 150 D 1 crate: 115 W x 237 H x 122 D 1 crate: 125 W x 122 H x 150 D	583 KG	681 KG

DIMENSION & SHIPPING NOTES

Cross section of Inside: Approximately 36" wide by 28" deep. (91.4 cm by 71.1 cm)

Hearth Setting Area: 33" wide by 22" deep. (83.8 cm by 55.9 cm)

Recommended Minimum Space Requirements: 98.3" wide by 76.5" deep (249.7 cm by 194.3 cm)
(See General Dimension Diagram for details).

MORE: See each model page on hotkilns.com to download PDF General Dimension Drawings for more outside and inside dimensions, minimum space requirements, BTU ventilation requirements, and kiln weight. See the Shipping Tab on the model page for complete shipping dimension and shipping weight information.

TB2318

Temperature Rating: Cone 10

Volume: 9.6 Cubic Feet

Brick Thickness: 3" Brick

Inside: 34.75" D x 18" H

Outside Dimensions: 68" W x 72" H x 47" D

Shipping Dim with Vent & Furn Kit: 2 Crate (49" W x 46" H x 59" D & 49" W x 84" H x 59" D)

Ship Weight (Kiln): 905 LBS

Ship Weight (Kiln, Vent & Furn Kit): 1,005 LBS

FURNITURE KIT FOR TB2318

Part Number: H-T-K418/00

Includes: Six 22" X 11" X 3/4" Rectangular Shelves (3/4" thick), Six Each 1/2", 1", 2", 4", 6", and 8" Square Posts, and One Pair Heat Resistant. Gloves.



T2327

Temperature Rating: Cone 10

Volume: 14.4 Cubic Feet

Brick Thickness: 3" Brick

Inside: 34.75" D x 27" H

Outside Dimensions: 68" W x 84" H x 47" D

Shipping Dim with Vent & Furn Kit: 2 Crate (49" W x 72" H x 59" D & 49" W x 84" H x 59" D)

Ship Weight (Kiln): 1,035 LBS

Ship Weight (Kiln, Vent & Furn Kit): 1,170 LBS

FURNITURE KIT FOR T2327

Part Number: H-T-K427/00

Includes: Nine 22" X 11" X 3/4" Rectangular Shelves (3/4" thick), Six Each 1/2", 1", 2", 4", 6", and 8" Square Posts, and One Pair Heat Resistant Gloves.

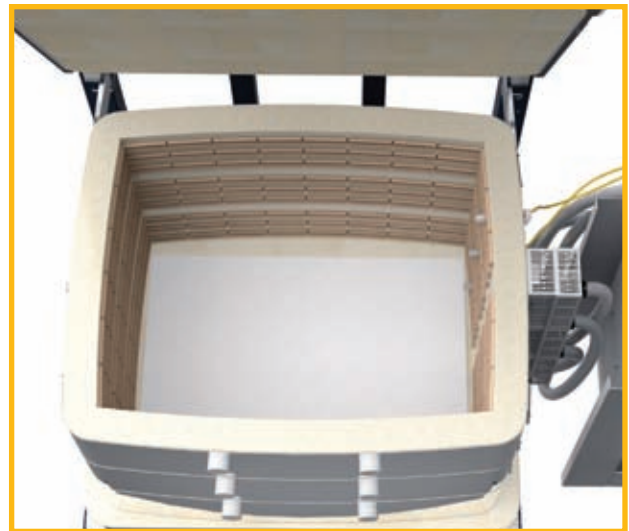

T2336

Temperature Rating: Cone 10

Volume: 19.2 Cubic Feet

Brick Thickness: 3" Brick

Inside: 34.75" D x 36" H

Outside Dimensions: 68" W x 93" H x 47" D

Shipping Dim with Vent & Furn Kit: 2 Crate (49" W x 82" H x 59" D & 49" W x 84" H x 59" D)

Ship Weight (Kiln): 1,135 LBS

Ship Weight (Kiln, Vent & Furn Kit): 1,315 LBS

FURNITURE KIT FOR T2336

Part Number: H-T-K436/00

Includes: Twelve 22" X 11" X 3/4" Rectangular Shelves (3/4" thick), Twelve Each 1/2", 1", 2", 4", 6", and 8" Square Posts, and One Pair Heat Resistant Gloves.

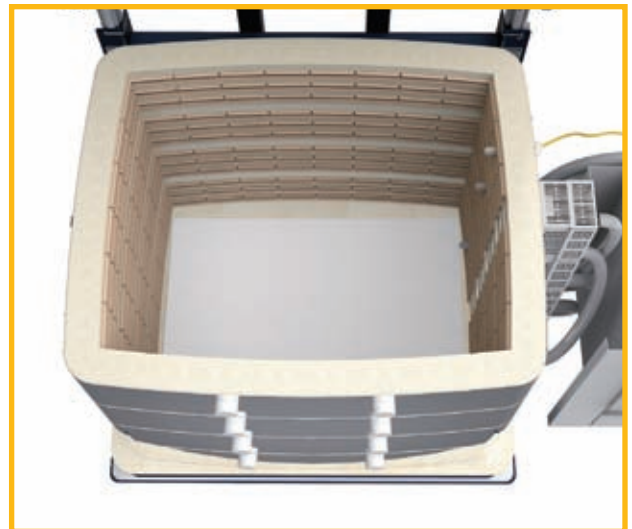

T2345

Temperature Rating: Cone 10

Volume: 24.0 Cubic Feet

Brick Thickness: 3" Brick

Inside: 34.75" D x 45" H

Outside Dimensions: 68" W x 102" H x 47" D

Shipping Dim with Vent & Furn Kit: 3 Crate (49" W x 72" H x 59" D, 49" W x 36" H x 59" D, & 49" W x 84" H x 59" D)

Ship Weight (Kiln): 1,285 LBS

Ship Weight (Kiln, Vent & Furn Kit): 1,500 LBS

FURNITURE KIT FOR T2345

Part Number: H-T-K425/00

Includes: Fifteen 22" X 11" X 3/4" Rectangular Shelves (3/4" thick), Twelve Each 1/2", 1", 2", 4", 6", and 8" Square Posts, and One Pair Heat Resistant Gloves.

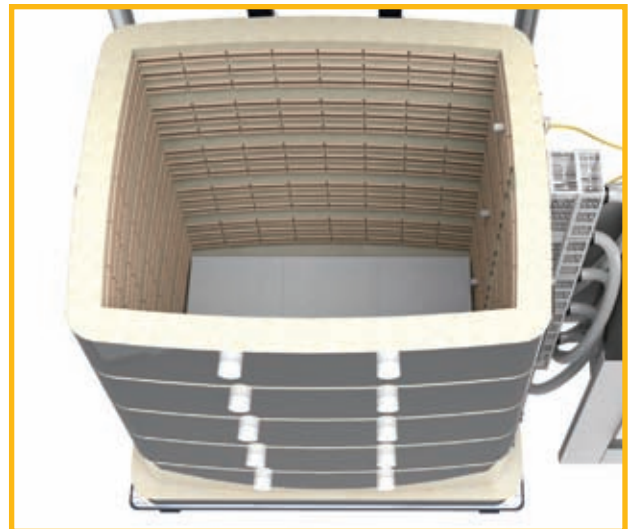

Electrical Specifications for T3400 Series (USA)

Standard Models							Powered Bottom Models				
Model Number	Part Number	Volt/Phase	Watts	Amps	Wire Size	Fuse Size	Part Number	Watts	Amps	Wire Size	Fuse Size
TB3418-D-240	K-T-3418/31	240/1P	19,934	83.1	1 ga	110	K-T-341P/31	26,579	110.7	3/0	150
TB3418-D-240-3P	K-T-3418/32	240/3P	19,934	71.9	2 ga	90	K-T-341P/32	26,579	71.9	2 ga	90
TB3418-D-208	K-T-3418/21	208/1P	19,934	95.8	1/0	125	K-T-341P/21	26,579	127.8	4/0	175
TB3418-D-208-3P	K-T-3418/22	208/3P	19,934	83.0	1 ga	110	K-T-341P/22	26,579	83.0	1 ga	110
TB3418-D-480-3P	K-T-3418/62	480/3P	19,934	24.0	10 ga	30	K-T-341P/62	26,579	36.0	6 ga	50
T3427-D-240	K-T-3427/31	240/1P	24,936	103.9	3/0	150	K-T-342P/31	30,477	127.0	4/0	175
T3427-D-240-3P	K-T-3427/32	240/3P	24,936	60.0	3 ga	80	K-T-342P/32	30,477	80.8	1 ga	110
T3427-D-208	K-T-3427/21	208/1P	24,936	119.9	3/0	150	K-T-342P/21	30,477	146.5	250 mcm	200
T3427-D-208-3P	K-T-3427/22	208/3P	24,936	69.2	2 ga	90	K-T-342P/22	30,477	93.2	1/0	125
T3427-D-480-3P	K-T-3427/62	480/3P	24,936	30.0	8 ga	40	K-T-342P/62	30,477	40.0	6 ga	50
TB3427-D-240	K-T-342B/31	240/1P	29,901	124.6	4/0	175	K-T-342W/31	36,546	152.3	250 mcm	200
TB3427-D-240-3P	K-T-342B/32	240/3P	29,901	71.9	2 ga	90	K-T-342W/32	36,546	96.9	1/0	125
TB3427-D-208	K-T-342B/21	208/1P	29,901	143.8	250 mcm	200	K-T-342W/21	36,546	175.7	300 mcm	225
TB3427-D-208-3P	K-T-342B/22	208/3P	29,901	83.0	1 ga	110	K-T-342W/22	36,546	111.8	3/0	150
TB3427-D-480-3P	K-T-342B/62	480/3P	29,901	36.0	6 ga	50	K-T-342W/62	36,546	48.0	6 ga	60
T3436-D-240	K-T-3436/31	240/1P	33,248	138.5	4/0	175	K-T-343P/31	38,789	161.6	300 mcm	225
T3436-D-240-3P	K-T-3436/32	240/1P	33,248	91.6	1/0	125	K-T-343P/32	38,789	110.1	3/0	150
T3436-D-208	K-T-3436/21	208/1P	33,248	159.8	250 mcm	200	K-T-343P/21	38,789	186.5	350 mcm	250
T3436-D-208-3P	K-T-3436/22	208/3P	33,248	105.7	3/0	150	K-T-343P/22	38,789	127.1	4/0	175
T3436-D-480-3P	K-T-3436/62	480/3P	33,248	40.0	6 ga	50	K-T-343P/62	38,789	50.0	4 ga	70
TB3436-D-240	K-T-343B/31	240/1P	39,868	166.1	300 mcm	225	K-T-343W/31	46,513	193.8	350 mcm	250
TB3436-D-240-3P	K-T-343B/32	240/1P	39,868	109.9	3/0	150	K-T-343W/32	46,513	132.1	4/0	175
TB3436-D-208	K-T-343B/21	208/1P	39,868	191.7	350 mcm	250	K-T-343W/21	46,513	223.6	500 mcm	300
TB3436-D-208-3P	K-T-343B/22	208/3P	39,868	126.8	4/0	175	K-T-343W/22	46,513	152.4	250 mcm	200
TB3436-D-480-3P	K-T-343B/62	480/3P	39,868	48.0	6 ga	60	K-T-343W/62	46,513	60.0	3 ga	80
T3445-D-240	K-T-3445/31	240/1P	41,560	173.2	300 mcm	225	K-T-344P/31	47,101	196.3	350 mcm	250
T3445-D-240-3P	K-T-3445/32	240/3P	41,560	120.0	3/0	150	K-T-344P/32	47,101	120.0	3/0	150
T3445-D-208	K-T-3445/21	208/1P	41,560	199.8	350 mcm	250	K-T-344P/21	47,101	226.4	500 mcm	300
T3445-D-208-3P	K-T-3445/22	208/3P	41,560	138.4	4/0	175	K-T-344P/22	47,101	138.4	4/0	175
T3445-D-480-3P	K-T-3445/62	480/3P	41,560	50.0	4 ga	70	K-T-344P/62	47,101	60.0	3 ga	80
TB3445-D-240	K-T-344B/31	240/1P	49,835	207.7	400 mcm	275	K-T-344W/31	56,480	235.3	500 mcm	300
TB3445-D-240-3P	K-T-344B/32	240/3P	49,835	143.9	250 mcm	200	K-T-344W/32	56,480	143.9	250 mcm	200
TB3445-D-208	K-T-344B/21	208/1P	49,835	239.6	500 mcm	300	K-T-344W/21	56,480	271.5	500 mcm	350
TB3445-D-208-3P	K-T-344B/22	208/3P	49,835	166.0	350 mcm	225	K-T-344W/22	56,480	166.0	300 mcm	225
TB3445-D-480-3P	K-T-344B/62	480/3P	49,835	60.0	3 ga	80	K-T-344W/62	56,480	72.0	2 ga	90

SEE PAGE 41 FOR ELECTRICAL NOTES

Electrical Specifications for T3400 Series (World)

Standard Models							Powered Bottom Models				
Model Number	Part Number	Volt/Phase	Watts	Amps	Wire Size	Fuse Size	Part Number	Watts	Amps	Wire Size	Fuse Size
TB3418-D-220	K-T-B348/41	220/1P	19,934	90.6	1/0	125	K-T-341P/41	26,579	120.8	4/0	175
TB3418-D-380-3PY	K-T-B348/52	380/3PY	11,592	45.3	6 ga	60	K-T-341P/52	26,579	45.3	6 ga	60
TB3418-D-400-3PY	K-T-B348/82	400/3PY	11,592	43.3	6 ga	60	K-T-341P/82	26,579	43.3	6 ga	60
TB3418-D-415-3P4	K-T-B348/72	415/3PY	11,592	41.5	6 ga	60	K-T-341P/72	26,579	41.5	6 ga	60
T3427-D-220	K-T-3427/41	220/1P	24,936	113.3	3/0	150	K-T-342P/41	30,477	138.5	4/0	175
T3427-D-380-3PY	K-T-3427/52	380/3PY	24,936	37.8	6 ga	50	K-T-342P/52	30,477	63.0	3 ga	80
T3427-D-400-3PY	K-T-3427/82	400/3PY	24,936	36.1	6 ga	50	K-T-342P/82	30,477	60.2	3 ga	80
T3427-D-415-3PY	K-T-3427/72	415/3PY	24,936	34.6	6 ga	50	K-T-342P/72	30,477	57.7	3 ga	80
TB3427-D-220	K-T-342B/41	220/1P	29,901	135.9	4/0	175	K-T-342W/41	36,546	166.1	300 mcm	225
TB3427-D-380-3PY	K-T-342B/52	380/3PY	29,901	45.3	6 ga	60	K-T-342W/52	36,546	75.5	1 ga	100
TB3427-D-400-3PY	K-T-342B/82	400/3PY	29,901	43.3	6 ga	60	K-T-342W/82	36,546	72.2	1 ga	100
TB3427-D-415-3PY	K-T-342B/72	415/3PY	29,901	41.5	6 ga	60	K-T-342W/72	36,546	69.2	2 ga	90
T3436-D-220	K-T-3436/41	220/1P	33,248	151.1	250 mcm	200	K-T-343P/41	38,789	176.3	300 mcm	225
T3436-D-380-3PY	K-T-3436/52	380/3PY	33,248	75.6	1 ga	100	K-T-343P/52	38,789	75.6	1 ga	100
T3436-D-400-3PY	K-T-3436/82	400/3PY	33,248	72.3	1 ga	100	K-T-343P/82	38,789	72.3	1 ga	100
T3436-D-415-3PY	K-T-3436/72	415/3PY	33,248	69.3	2 ga	90	K-T-343P/72	38,789	69.3	2 ga	90
TB3436-D-220	K-T-343B/41	220/1P	39,868	181.2	350 mcm	250	K-T-343W/41	46,513	211.4	400 mcm	275
TB3436-D-380-3PY	K-T-343B/52	380/3PY	39,868	90.6	1/0	125	K-T-343W/52	46,513	90.6	1/0	125
TB3436-D-400-3PY	K-T-343B/82	400/3PY	39,868	86.7	1 ga	110	K-T-343W/82	46,513	86.7	1 ga	110
TB3436-D-415-3PY	K-T-343B/72	415/3PY	39,868	83.1	1 ga	110	K-T-343W/72	46,513	83.1	1 ga	110
T3445-D-220	K-T3445/41	220/1P	41,560	188.9	350 mcm	250	K-T344P/41	47,101	214.1	400 mcm	275
T3445-D-380-3PY	K-T3445/52	380/3PY	41,560	75.6	1 ga	100	K-T344P/52	47,101	75.6	1 ga	100
T3445-D-400-3PY	K-T3445/82	400/3PY	41,560	72.3	1 ga	100	K-T344P/82	47,101	72.3	1 ga	100
T3445-D-415-3PY	K-T3445/72	415/3PY	41,560	69.3	2 ga	90	K-T344P/72	47,101	69.3	2 ga	90
TB3445-D-220	K-T344B/41	220/1P	49,835	226.5	500 mcm	300	K-T-344W/41	56,480	256.7	500 mcm	350
TB3445-D-380-3PY	K-T344B/52	380/3PY	49,835	52.5	4 ga	70	K-T-344W/52	56,480	90.6	1/0	125
TB3445-D-400-3PY	K-T344B/82	400/3PY	49,835	49.8	4 ga	70	K-T-344W/82	56,480	86.7	1 ga	110
TB3445-D-415-3PY	K-T344B/72	415/3PY	49,835	48.0	6 ga	60	K-T-344W/72	56,480	83.1	1 ga	110

ELECTRICAL NOTES FOR T3400 SERIES

For Model Number Powered Bottom Model: Add a "PB" after the "D" (Example = T3427-D-PB-240-1).

UL Listing: All models are c-MET-us listed.

Control Panels: All T3400 kilns get a floor standing panel. NEMA 1 panel are recommended but not required for 480 volts.

TB MODELS: TB models have more power than the regular T model kilns. The higher powered TB elements are always used on the TB3418 because of the large ratio of unheated surface area.

480 Volt Models with Quad Element Option: See website kiln pages for electrical specifications.

Dimension & Weight Specifications for T3400 Series

Model Number	Inside Height	Cubic Feet	Furniture Kit	Furniture Kit Part No.	Outside Dimensions	Shipping Dimensions (with Kit)	Ship Weight Kiln Only	Ship Weight Kiln + Kit
TB3418-D	18"	13.8	4 shelves, 1 post kit	H-T-K518/00	76" W x 72" H x 53" D	1 crate: 50" W x 46" H x 56" D 1 crate: 45" W x 74" H x 48" D	1,065 lbs	1,215 lbs
T3427-D	27"	20.7	6 shelves, 1 post kit	H-T-K527/00	76" W x 84" H x 53" D	1 crate: 50" W x 72" H x 56" D 1 crate: 45" W x 93" H x 48" D	1,215 lbs	1,420 lbs
T3436-D	36"	27.6	8 shelves, 2 post kits	H-T-K536/00	76" W x 93" H x 53" D	1 crate: 50" W x 82" H x 56" D 1 crate: 45" W x 93" H x 48" D	1,340 lbs	1,615 lbs
T3445-D	45"	34.6	10 shelves, 2 post kits	H-T-K545/00	76" W x 102" H x 53" D	1 crate: 50" W x 82" H x 56" D 1 crate: 45" W x 93" H x 48" D 1 crate: 50" W x 48" H x 56" D	1,505 lbs	1,840 lbs
METRIC DIMENSIONS (CM, LITERS & KG)								
TB3418-D	45.7	392 L	4 shelves, 1 post kit	H-T-K518/00	193 W x 183 H x 135 D	1 crate: 127 W x 117 H x 143 D 1 crate: 115 W x 213 H x 122 D	484 KG	552 KG
T3427-D	68.6	588 L	6 shelves, 1 post kit	H-T-K527/00	193 W x 213 H x 135 D	1 crate: 127 W x 183 H x 143 D 1 crate: 115 W x 237 H x 122 D	552 KG	645 KG
T3436-D	91.4	783 L	8 shelves, 2 post kits	H-T-K536/00	193 W x 236 H x 135 D	1 crate: 127 W x 209 H x 143 D 1 crate: 115 W x 237 H x 122 D	608 KG	733 KG
T3445-D	114.3	979 L	10 shelves, 2 post kits	H-T-K545/00	193 W x 259 H x 135 D	1 crate: 127 W x 143 H x 143 D 1 crate: 115 W x 237 H x 122 D 1 crate: 127 W x 122 H x 143 D	683 KG	835 KG

DIMENSION & SHIPPING NOTES

Cross section of Inside: Approximately 45" wide by 34" deep. (114.3 cm by 86.4 cm)

Hearth Setting Area: 42" wide by 28" deep. (106.7 cm by 71.1 cm)

Recommended Minimum Space Requirements: 107.6" wide by 79.0" deep (273.3 cm by 200.6 cm)
(See General Dimension Diagram for details).

MORE: See each model page on hotkilns.com to download PDF General Dimension Drawings for more outside and inside dimensions, minimum space requirements, BTU ventilation requirements, and kiln weight. See the Shipping Tab on the model page for complete shipping dimension and shipping weight information.

TB3418

Temperature Rating: Cone 10

Volume: 13.8 Cubic Feet

Brick Thickness: 3" Brick

Inside: 43.5" D x 18" H

Outside Dimensions: 76" W x 72" H x 53" D

Shipping Dim with Vent & Furn Kit: 2 Crate (50" W x 46" H x 46" D & 50" W x 74" H x 46" D)

Ship Weight (Kiln): 1,065 LBS

Ship Weight (Kiln, Vent & Furn Kit): 1,215 LBS

FURNITURE KIT FOR TB3418

Part Number: H-T-K518/00

Includes: Six 28" X 14" X 3/4" Rectangular Shelves (3/4" thick), Twelve Each 1/2", 1", 2", 4", 6", and 8" Square Posts, and One Pair Heat Resistant. Gloves.



T3427

Temperature Rating: Cone 10

Volume: 20.7 Cubic Feet

Brick Thickness: 3" Brick

Inside: 43.5" D x 27" H

Outside Dimensions: 76" W x 84" H x 53" D

Shipping Dim with Vent & Furn Kit: 3 Crate (50" W x 72" H x 46" D & 50" W x 84" H x 46" D)

Ship Weight (Kiln): 1,215 LBS

Ship Weight (Kiln, Vent & Furn Kit): 1,420 LBS

FURNITURE KIT FOR T3427

Part Number: H-T-K527/00

Includes: Nine 28" X 14" X 3/4" Rectangular Shelves (3/4" thick), Twelve Each 1/2", 1", 2", 4", 6", and 8" Square Posts, and One Pair Heat Resistant Gloves.

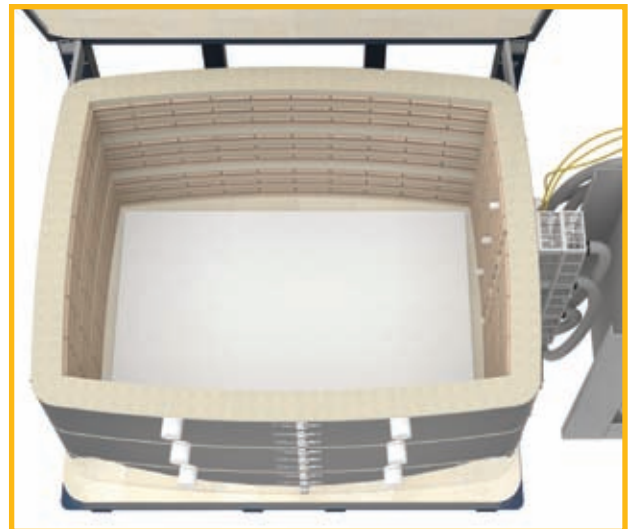

T3436

Temperature Rating: Cone 10

Volume: 27.6 Cubic Feet

Brick Thickness: 3" Brick

Inside: 43.5" D x 36" H

Outside Dimensions: 76" W x 93" H x 53" D

Shipping Dim with Vent & Furn Kit: 2 Crate (50" W x 82" H x 46" D & 50" W x 84" H x 46" D)

Ship Weight (Kiln): 1,340 LBS

Ship Weight (Kiln, Vent & Furn Kit): 1,615 LBS

FURNITURE KIT FOR T3436

Part Number: H-T-K536/00

Includes: Twelve 28" X 14" X 3/4" Rectangular Shelves (3/4" thick), Twelve Each 1/2", 1", 2", 4", 6", and 8" Square Posts, and One Pair Heat Resistant Gloves.

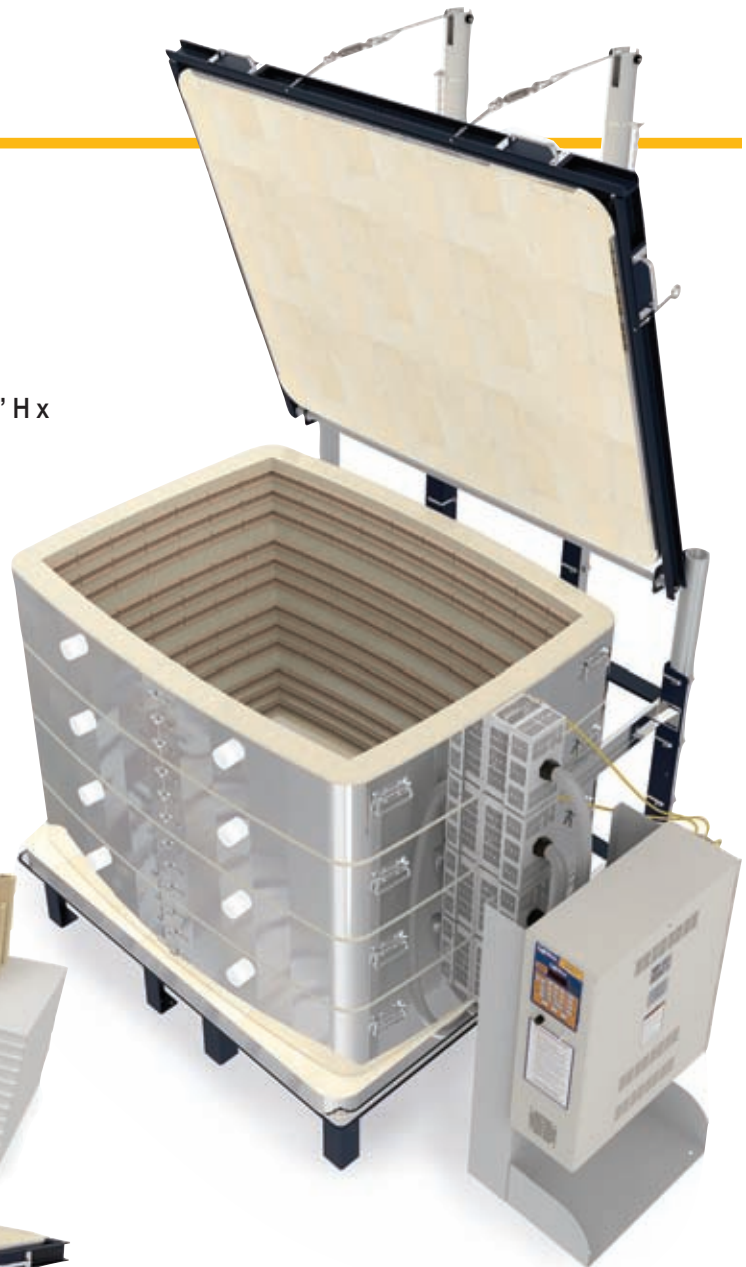

T3445

Temperature Rating: Cone 10

Volume: 34.6 Cubic Feet

Brick Thickness: 3" Brick

Inside: 43.5" D x 45" H

Outside Dimensions: 76" W x 102" H x 53" D

Shipping Dim with Vent & Furn Kit: 3 Crate (50" W x 82" H x 46" D, 50" W x 36" H x 46" D, & 50" W x 84" H x 46" D)

Ship Weight (Kiln): 1,505 LBS

Ship Weight (Kiln, Vent & Furn Kit): 1,840 LBS

FURNITURE KIT FOR T3445

Part Number: H-T-K545/00

Includes: Fifteen 28" X 14" X 3/4" Rectangular Shelves (3/4" thick), Eighteen Each 1/2", 1", 2", 4", 6", and 8" Square Posts, and One Pair Heat Resistant Gloves.



What Makes DaVinci Kilns Built to Last?

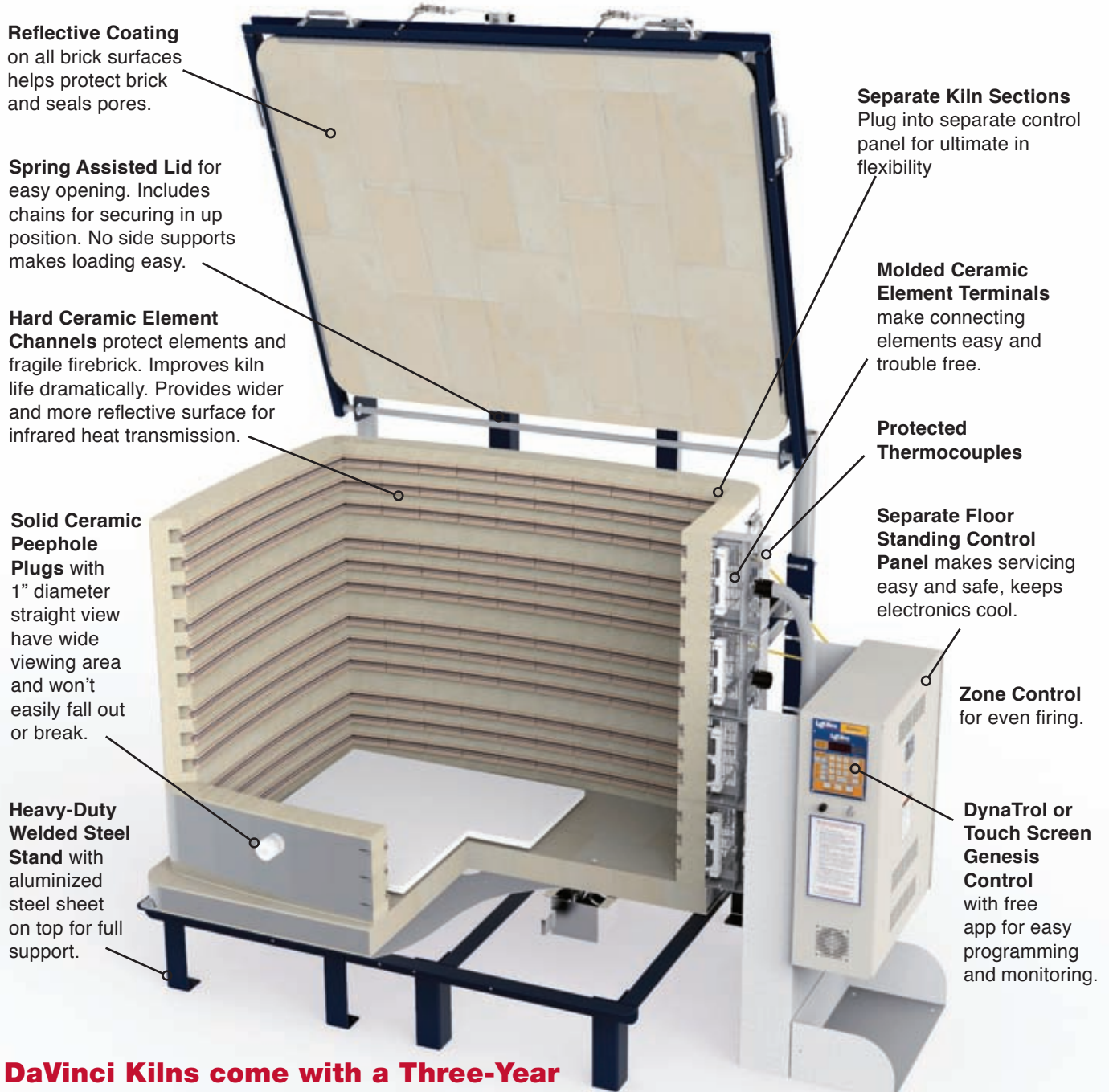

DaVinci Kilns come with a Three-Year Warranty because L&L kilns last longer.



505 Sharptown Road • Swedesboro, NJ 08085
Phone: 856.294.0077 • Fax: 856.294.0070
sales@hotkilns.com • hotkilns.com

KILNS BUILT TO LAST

Bulletin No: DV-0520